



fasteners plus...

 **SELECTA®**

FASTENERS PLUS CATALOG 2014-2015



TABLE OF CONTENTS

Our Advantages Inside Front Cover



Selecta’s Fastener Jars



i Fastener Starter Kit and Display



iii New Product Preview



.v Additional Selecta Products i

Product Line:



  Machine Screws Section A

  Nuts Section B

  Washers Section C



  Tapping & Self Drilling Screws Section D



 Drywall & Framing & Wood Screws Section E

   Fixture Hanging Products Section F

 Cable Ties & Plastic Accessories Section G

 Bolts Section H

   Plastic Anchors • Kits • Anchoring Products Section I

   Special Electrical Fasteners: Grounding Screws • Switch Plate Screws • Staples • Straps Section J

Tools • Drill Bits • Insert, Power, Auger, & Boring Bits • Saws • Blades • Screwdrivers •
Accessories • Displays Section K

New Products:

Work Gloves • Shoe Covers Section L

Safety Products: Helmets • Vests • First Aid Kits • Glasses Section M

Tapes: Electrical • Duct • Barricade • Underground • Detectable • Silicone Self-Fusing Section N

Tools: Shovels • Post Hole Diggers • Rakes • Picks & Sledges • Tape Measures Section O

Markers: Lumber Crayons • Permanent Marking Pens Section P

 Duct Seal Section Q

Knockout Seals: Snap-In • Screw/Bar Type Section R

Chemical Products: CRC Section S

Paint: Rust-Oleum Aerosol Cans, Accessories, NeverWet® & LeakSeal® Section T

Product Alpha Index INDEX 1

Catalog Number Numeric Index INDEX 2

Description Abridgements INDEX 7

Manufacturers Line Card INDEX 8 & Inside Back Cover



The colored circles above, represent the colors of the lid associated with that product.

All specifications and dimensions are for reference only. If specific information is needed and/or of critical nature, contact Selecta Products headquarters for specific information before ordering.

©2014 SELECTA PRODUCTS, INC.

“SELECTA” is a registered trademark (Marca Registrada, “Marque Déposée”) of Selecta Products, Inc. a California corporation.



How Selecta Fasteners Stack-Up...



Wide Mouth Jars
make it easy to grab what you need –
even with gloves!

Color Coded Lids
help find the fastener you need fast!

Dual Part Numbers
allow you to keep your numbers or use
ours. Switching to Selecta is a snap!

Wider Jar Footprint
lets jars easily stack on shelves!

Jars Look Great in our Display Rack
which assists in selling more fasteners!



Fastener Starter Kit

KIT NUMBER: FSK



32" W x 22" D x 77" H

Spaces for 56 individual SKU's of our 3" x 3" square jars. Picture shown is not necessarily the products in the kit.



Our innovative color-coded label /lid system provides instant visual recognition to all our hardware product categories. All packed in convenient, durable square plastic jars.

RH81J
100 Count

Compare with: XYZ
X-RH81

Machine Screw
Round Combo Head
Steel, Zinc Plated
8-32 x 1

Phone: 800-555-1234
Fax: 800-555-1235

Jars are normally shipped with our own label. An exciting feature, offered free of charge, is the ability to showcase your company on our jar label.

Above, is a **co-label design**, and below is a **private label design**. Our staff will work with you to design a label that best fits your needs.

XYZ Electric Supply Co.

RH81J
100 Count

Compare with: XYZ
X-RH81

Machine Screw
Round Combo Head
Steel, Zinc Plated
8-32 x 1

Phone: 800-555-1234
Fax: 800-555-1235

Complete kit listing on facing page.

Selecta Fastener Starter Kit: FSK⁺

	PART NUMBER	DESCRIPTION	QTY OF JARS/BOXES	PCS PER BOX /JAR	QTY
HEADER	PAK14	10 X 1" Pan head combo/conical anchor kit	6 Plastic Boxes	100 ea screw & anchor	6*
	HPAK14	10 X 1" Hex washer head/conical anchor kit	6 Plastic Boxes	100 ea screw & anchor	6*
	MXK14	10 X 1" Pan head combo/winged anchor kit	6 Plastic Boxes	100 ea screw & anchor	6*
	SN2ZK	Zip-it metal anchor kit	6 Plastic Boxes	50 ea screw & anchor	6*
	SN1K	Zip-it plastic anchor kit	6 Plastic Boxes	50 ea screw & anchor	6*
SHELF 1	TS1034J	10 X 3/4 Pan head combo tapping screw	7 Plastic Jars	100 screws	700
	TS101J	10 X 1 Pan head combo tapping screw	7 Plastic Jars	100 screws	700
	TS10114J	10 X 1-1/4 Pan head combo tapping screw	7 Plastic Jars	100 screws	700
	TS10112J	10 X 1-1/2 Pan head combo tapping screw	7 Plastic Jars	100 screws	700
	TS102J	10 X 2 Pan head combo tapping screw	5 Plastic Jars	100 screws	500
	DS1034J	10 X 3/4 Hex washer head tapping screw	7 Plastic Jars	100 screws	700
	DS101J	10 X 1 Hex washer head tapping screw	7 Plastic Jars	100 screws	700
	DS10114J	10 X 1-1/4 Hex washer head tapping screw	7 Plastic Jars	100 screws	700
SHELF 2	DS10112J	10 X 1-1/2 Hex washer head tapping screw	7 Plastic Jars	100 screws	700
	DS102J	10 X 2 Hex washer head tapping screw	5 Plastic Jars	100 screws	500
	TK1012J	10 X 1/2 Hex washer head self drilling screw	7 Plastic Jars	100 screws	700
	TK1034J	10 X 3/4 Hex washer head self drilling screw	7 Plastic Jars	100 screws	700
	TK101J	10 X 1 Hex washer head self drilling screw	7 Plastic Jars	100 screws	700
	TK10114J	10 X 1-1/4 Hex washer head self drilling screw	7 Plastic Jars	100 screws	700
	TK10112J	10 X 1-1/2 Hex washer head self drilling screw	7 Plastic Jars	100 screws	700
	TK102J	10 X 2 Hex washer head self drilling screw	5 Plastic Jars	100 screws	500
SHELF 3	RH812J	8-32 X 1/2 Round head combo machine screw	7 Plastic Jars	100 screws	700
	RH834J	8-32 X 3/4 Round head combo machine screw	7 Plastic Jars	100 screws	700
	RH81J	8-32 X 1 Round head combo machine screw	7 Plastic Jars	100 screws	700
	RH8114J	8-32 X 1-1/4 Round head combo machine screw	7 Plastic Jars	100 screws	700
	RH8112J	8-32 X 1-1/2 Round head combo machine screw	7 Plastic Jars	100 screws	700
	RH82J	8-32 X 2 Round head combo machine screw	7 Plastic Jars	100 screws	700
	RH8212J	8-32 X 2-1/2 Round head combo machine screw	5 Plastic Jars	100 screws	500
	RH83J	8-32 X 3 Round head combo machine screw	5 Plastic Jars	100 screws	500
SHELF 4	RH1438J	1/4-20 X 3/8 Round head combo machine screw	7 Plastic Jars	100 screws	700
	RH1412J	1/4-20 X 1/2 Round head combo machine screw	7 Plastic Jars	100 screws	700
	RH1434J	1/4-20 X 3/4 Round head combo machine screw	7 Plastic Jars	100 screws	700
	RH141J	1/4-20 X 1 Round head combo machine screw	7 Plastic Jars	100 screws	700
	RH14114J	1/4-20 X 1-1/4 Round head combo machine screw	7 Plastic Jars	100 screws	700
	RH14112J	1/4-20 X 1-1/2 Round head combo machine screw	5 Plastic Jars	100 screws	500
	RH142J	1/4-20 X 2 Round head combo machine screw	4 Plastic Jars	100 screws	400
	GS1038J	10-32 X 3/8 Hex washer combo ground screw	7 Plastic Jars	100 screws	700
SHELF 5	DW6114J	6 X 1-1/4 Bugle head fine thrd black phos drywall screw	7 Plastic Jars	100 screws	700
	DW6158J	6 X 1-5/8 Bugle head fine thrd black phos drywall screw	7 Plastic Jars	100 screws	700
	DW62J	6 X 2 Bugle head fine thrd black phos drywall screw	7 Plastic Jars	100 screws	700
	SCW812J	8 X 1/2 Modified Truss head Phillips self drilling screw	7 Plastic Jars	100 screws	700
	WHP812J	8 X 1/2 Modified Truss head Phillips self piercing screw	7 Plastic Jars	100 screws	700
	PDW6716J	6 x 7/16 Pan head Phillips framing screw black phos	7 Plastic Jars	100 screws	700
	WA14J	8-10 Plastic conical anchor	7 Plastic Jars	100 anchors	700
	MX14J	8-10 Plastic winged anchor	7 Plastic Jars	100 anchors	700
	SHELF 6	FW141J	1/4 X 1 Fender washer	7 Plastic Jars	100 washers
FW14114J		1/4 x 1-1/4 Fender washer	7 Plastic Jars	100 washers	700
FW38114J		3/8 X 1-1/4 Fender washer	7 Plastic Jars	100 washers	700
FW38112J		3/8 X 1-1/2 Fender washer	5 Plastic Jars	100 washers	500
SAE8J		#8 SAE flat washer	7 Plastic Jars	100 washers	700
SAE14J		1/4" SAE flat washer	7 Plastic Jars	100 washers	700
LW14J		1/4" Medium split lock washer	7 Plastic Jars	100 washers	700
LW38J		3/8" Medium split lock washer	7 Plastic Jars	100 washers	700
SHELF 7	N832J	8-32 Hex nut	7 Plastic Jars	100 nuts	700
	N1420J	1/4-20 Hex nut	7 Plastic Jars	100 nuts	700
	N3816J	3/8-16 Hex nut	7 Plastic Jars	100 nuts	700
	N1213J	1/2-13 Hex nut	4 Plastic Jars	50 nuts	200
	HCS141J	1/4-20 X 1 Hex head full thrd bolt	7 Plastic Jars	100 bolts	700
	HCS381J	3/8-16 X 1 Hex head full thrd bolt	4 Plastic Jars	100 bolts	400
	MSA14J	1/4-20 Machine screw anchor	4 Plastic Jars	100 anchors	400
	MSA38J	3/8-16 Machine screw anchor	2 Plastic Jars	50 anchors	100
	FASTENERRACK			1	

*When you order the FSK Kit, the packing list and invoice you receive will read as the contents appear in this complete kit list.
 *5 peg board hooks included for the above kit items: 6 each, 3 for hooks on display and 3 for back-up.



New Product Preview

WORK GLOVES (Section L)

SHOE COVERS (Section L)

SAFETY PRODUCTS (Section M)

- Safety Helmets
- Safety Vests
- Safety Glasses

TAPES (Section N)

- Electrical Tape
- Duct Tape
- Barricade Tape
- Silicone Self-Fusing Tape

TOOLS (Section O)

- Shovels
- Picks & Sledges
- Tape Measures



New Product Preview

MARKERS (Section P)

- Lumber Crayons
- Permanent Marking Pens

DUCT SEAL (Section Q)

KNOCK-OUT SEALS (Section R)

- Snap-In Seals
- Screw/Bar Type Knock-Out Seals

RELATED CHEMICAL PRODUCTS FROM CRC* (Section S)

- Cutting Oil
- Zinc Rich Galvanize
- Minimal Expansion Foam



* All products from CRC are available.
The above products are shown for reference only as being related with fastener products.

RUST-OLEUM PAINT & ACCESSORIES (Section T)

- Aerosol Paint Cans
- Paint Accessories
- NeverWet®
- LeakSeal®





Additional Selecta Products

SWITCHES

- Toggle, Pushbutton, Pullchain, Rotary, Rocker

TERMINALS

- Ring, Spade, Bullet, Quick Connect, Butt Connectors, Closed End Connectors and other styles

INDICATOR LIGHTS

- Incandescent, Neon & LED, Round Indicating Lamp Holders, Replacement Lamps

CLIPS

- Alligator, Battery Booster, Crocodile, General Purpose Test, Mini-Gator, Welding

RELAYS

- General Purpose, Sockets, Solid State

CUTLER HAMMER DP CONTACTORS

DURACELL

- Batteries, Flashlights

ENERGIZER

- Batteries, Flashlights

COOLERS

MICRO SWITCH

CRC PRODUCT LINE

SEALED LEAD ACID BATTERIES



Round Head Machine Screws • Slotted/Phillips Combo Zinc-Plated Steel

CATALOG NUMBER*	UPC NUMBER	DIAMETER	LENGTH	STD PAK [◇] PCS/PKG	PKG STYLE*	CASE QTY	WEIGHT/PKG (lbs.)
* RH614J	78103551011	6-32	1/4	100	Jar	48 Jars	0.23
RH638J	78103551013	6-32	3/8	100	Jar	48 Jars	0.26
RH612J	78103551014	6-32	1/2	100	Jar	48 Jars	0.28
RH634J	78103551016	6-32	3/4	100	Jar	48 Jars	0.36
RH61J	78103551017	6-32	1	100	Jar	48 Jars	0.45
RH6114J	78103551018	6-32	1-1/4	100	Jar	48 Jars	0.50
RH6112J	78103551019	6-32	1-1/2	100	Jar	48 Jars	0.58
RH62J	78103551021	6-32	2	100	Jar	48 Jars	0.73
RH6212J	78103551022	6-32	2-1/2	100	Jar	36 Jars	0.87
RH63J	78103551023	6-32	3	100	Jar	36 Jars	1.01
RH838J	78103551029	8-32	3/8	100	Jar	48 Jars	0.36
RH812J	78103551030	8-32	1/2	100	Jar	48 Jars	0.41
RH834J	78103551031	8-32	3/4	100	Jar	48 Jars	0.50
RH81J	78103551032	8-32	1	100	Jar	48 Jars	0.63
RH8114J	78103551033	8-32	1-1/4	100	Jar	48 Jars	0.72
RH8112J	78103551034	8-32	1-1/2	100	Jar	48 Jars	0.84
* RH8134J	78103551035	8-32	1-3/4	100	Jar	48 Jars	0.96
RH82J	78103551036	8-32	2	100	Jar	48 Jars	1.01
RH8212J	78103551037	8-32	2-1/2	100	Jar	36 Jars	1.27
RH83J	78103551038	8-32	3	100	Jar	36 Jars	1.54
* RH1038J	78103551041	10-24	3/8	100	Jar	48 Jars	0.49
RH1012J	78103551042	10-24	1/2	100	Jar	48 Jars	0.56
RH1034J	78103551044	10-24	3/4	100	Jar	48 Jars	0.70
RH101J	78103551045	10-24	1	100	Jar	48 Jars	0.84
RH10114J	78103551046	10-24	1-1/4	100	Jar	48 Jars	1.04
RH10112J	78103551047	10-24	1-1/2	100	Jar	48 Jars	1.11
RH102J	78103551049	10-24	2	100	Jar	36 Jars	1.34
RH10212J	78103551050	10-24	2-1/2	100	Jar	36 Jars	1.65
RH103J	78103551051	10-24	3	100	Jar	24 Jars	1.96
RH104J	78103551053	10-24	4	100	Jar	12 Jars	2.56
RH138J	78103551057	10-32	3/8	100	Jar	48 Jars	0.48
RH112J	78103551058	10-32	1/2	100	Jar	48 Jars	0.56
RH134J	78103551060	10-32	3/4	100	Jar	48 Jars	0.72
RH11J	78103551061	10-32	1	100	Jar	48 Jars	0.91
RH1114J	78103551062	10-32	1-1/4	100	Jar	48 Jars	1.05
RH1112J	78103551063	10-32	1-1/2	100	Jar	48 Jars	1.15
RH12J	78103551064	10-32	2	100	Jar	36 Jars	1.50
* RH1212J	78103551066	10-32	2-1/2	100	Jar	36 Jars	1.77
* RH13J	78103551900	10-32	3	100	Jar	24 Jars	2.10
* RH14J	78103551904	10-32	4	100	Jar	12 Jars	2.81
RH1438J	78103551067	1/4-20	3/8	100	Jar	48 Jars	0.91
RH1412J	78103551068	1/4-20	1/2	100	Jar	48 Jars	1.02
RH1434J	78103551070	1/4-20	3/4	100	Jar	48 Jars	1.34
RH141J	78103551071	1/4-20	1	100	Jar	48 Jars	1.51
RH14114J	78103551072	1/4-20	1-1/4	100	Jar	48 Jars	1.74
RH14112J	78103551073	1/4-20	1-1/2	100	Jar	36 Jars	2.04
RH14134J	78103551074	1/4-20	1-3/4	100	Jar	36 Jars	2.30
RH142J	78103551075	1/4-20	2	100	Jar	24 Jars	2.58
RH14212J	78103551076	1/4-20	2-1/2	100	Jar	12 Jars	3.05
RH143J	78103551077	1/4-20	3	50	Jar	12 Jars	1.80
RH144J	78103551079	1/4-20	4	50	Jar	24 Jars	2.33
* RH5161J	78103551085	5/16-18	1	100	Jar	36 Jars	2.64
RH3812J	78103551090	3/8-16	1/2	100	Jar	36 Jars	2.75
RH3834J	78103551091	3/8-16	3/4	100	Jar	36 Jars	3.55
RH381J	78103551092	3/8-16	1	100	Jar	24 Jars	4.14
RH38114J	78103551093	3/8-16	1-1/4	100	Jar	12 Jars	4.88
RH38112J	78103551094	3/8-16	1-1/2	100	Jar	12 Jars	5.09
RH382J	78103551096	3/8-16	2	100	Jar	12 Jars	6.42
RH38212J	78103551098	3/8-16	2-1/2	100	Jar	12 Jars	7.62
RH383J	78103551200	3/8-16	3	50	Jar	12 Jars	4.46
RH384J	78103551204	3/8-16	4	50	Jar	12 Jars	5.73



* Sizes slotted only

* Jar version part number shown. Box and Bulk versions may be available. Contact Selecta for availability, part number and pricing.

◇ Other quantities per individual package may be available. Contact Selecta for details.

Round Head Stove Bolts • Slotted/Phillips Combo Zinc-Plated Steel with Hex Nut



CATALOG NUMBER*	UPC NUMBER	DIAMETER	LENGTH	STD PAK [◇] PCS/PKG	PKG STYLE*	CASE QTY	WEIGHT/PKG (lbs.)
RSB1438J	78103551190	1/4-20	3/8	100	Jar	48 Jars	1.59
RSB1412J	78103551191	1/4-20	1/2	100	Jar	48 Jars	1.74
RSB1434J	78103551192	1/4-20	3/4	100	Jar	36 Jars	1.98
RSB141J	78103551193	1/4-20	1	100	Jar	36 Jars	2.24
RSB14114J	78103551194	1/4-20	1-1/4	100	Jar	36 Jars	2.55
RSB14112J	78103551195	1/4-20	1-1/2	100	Jar	36 Jars	2.80
RSB142J	78103551197	1/4-20	2	50	Jar	24 Jars	1.67

Flat Head Machine Screws • Slotted & Phillips Zinc-Plated Steel



CATALOG NO. SLOTTED*	UPC NUMBER	CATALOG NO. PHILLIPS	UPC NUMBER	DIAMETER	LENGTH	STD PAK [◇] PCS/PKG	PKG STYLE*	CASE QTY	WEIGHT/PKG (lbs.)
FH612J	78103551114	FHP612J	78103551180	6-32	1/2	100	Jar	48 Jars	0.23
FH634J	78103551116	FHP634J	78103551181	6-32	3/4	100	Jar	48 Jars	0.34
FH61J	78103551117	FHP61J	78103551182	6-32	1	100	Jar	48 Jars	0.42
FH6114J	78103551118	FHP6114J	78103551183	6-32	1-1/4	100	Jar	48 Jars	0.47
FH6112J	78103551119	FHP6112J	78103551184	6-32	1-1/2	100	Jar	48 Jars	0.54
FH6134J	78103551120			6-32	1-3/4	100	Jar	48 Jars	0.63
FH62J	78103551121	FHP62J	78103551185	6-32	2	100	Jar	48 Jars	0.69
FH6212J	78103551122	FHP6212J	78103551186	6-32	2-1/2	100	Jar	48 Jars	0.85
FH63J	78103551123	FHP63J	78103551187	6-32	3	100	Jar	36 Jars	0.98
FH64J	78103551125			6-32	4	100	Jar	24 Jars	1.32
FH812J	78103551129			8-32	1/2	100	Jar	48 Jars	0.38
FH834J	78103551131			8-32	3/4	100	Jar	48 Jars	0.48
FH81J	78103551132			8-32	1	100	Jar	48 Jars	0.56
FH8114J	78103551133			8-32	1-1/4	100	Jar	48 Jars	0.69
FH8112J	78103551134			8-32	1-1/2	100	Jar	48 Jars	0.81
FH82J	78103551136			8-32	2	100	Jar	48 Jars	0.99
FH8212J	78103551137			8-32	2-1/2	100	Jar	48 Jars	1.23
FH83J	78103551138			8-32	3	100	Jar	36 Jars	1.46
FH112J	78103551158			10-32	1/2	100	Jar	48 Jars	0.49
FH134J	78103551159			10-32	3/4	100	Jar	48 Jars	0.66
FH11J	78103551160			10-32	1	100	Jar	48 Jars	0.82
FH1114J	78103551161			10-32	1-1/4	100	Jar	48 Jars	0.95
FH1112J	78103551162			10-32	1-1/2	100	Jar	? Jars	1.07
FH12J	78103551164			10-32	2	100	Jar	48 Jars	1.39
FH1412J	78103551168			1/4-20	1/2	100	Jar	48 Jars	0.82
FH1434J	78103551170			1/4-20	3/4	100	Jar	48 Jars	1.06
FH141J	78103551171			1/4-20	1	100	Jar	48 Jars	1.31
FH14114J	78103551172			1/4-20	1-1/4	100	Jar	48 Jars	1.57
FH14112J	78103551173			1/4-20	1-1/2	100	Jar	36 Jars	1.85
FH142J	78103551175			1/4-20	2	100	Jar	36 Jars	2.42
FH14212J	78103551177			1/4-20	2-1/2	100	Jar	12 Jars	2.86
FH143J	78103551179			1/4-20	3	100	Jar	12 Jars	3.43



* Jar version part number shown. Box and Bulk versions may be available. Contact Selecta for availability, part number and pricing.
[◇] Other quantities per individual package may be available. Contact Selecta for details.

Round Head Machine Screws • Slotted 18-8 Stainless Steel^Δ

CATALOG NUMBER*	UPC NUMBER	DIAMETER	LENGTH	STD PAK [◇] PCS/PKG	PKG STYLE*	CASE QTY	WEIGHT/PKG (lbs.)
SRH634J	78103558016	6-32	3/4	100	Jar	48 Jars	0.32
SRH61J	78103558017	6-32	1	100	Jar	48 Jars	0.44
SRH6112J	78103558019	6-32	1-1/2	100	Jar	48 Jars	0.54
SRH62J	78103558021	6-32	2	100	Jar	48 Jars	0.68
SRH834J	78103558031	8-32	3/4	100	Jar	48 Jars	0.53
SRH81J	78103558032	8-32	1	100	Jar	48 Jars	0.60
SRH8112J	78103558034	8-32	1-1/2	100	Jar	48 Jars	0.87
SRH82J	78103558036	8-32	2	100	Jar	48 Jars	1.01
SRH1034J	78103558044	10-24	3/4	100	Jar	48 Jars	0.70
SRH101J	78103558045	10-24	1	100	Jar	48 Jars	0.75
SRH10112J	78103558047	10-24	1-1/2	100	Jar	48 Jars	0.83
SRH102J	78103558049	10-24	2	100	Jar	36 Jars	1.34
SRH134J	78103558060	10-32	3/4	100	Jar	48 Jars	0.66
SRH11J	78103558061	10-32	1	100	Jar	48 Jars	0.90
SRH1112J	78103558063	10-32	1-1/2	100	Jar	48 Jars	1.17
SRH12J	78103558064	10-32	2	100	Jar	36 Jars	1.51
SRH1412J	78103558068	1/4-20	1/2	100	Jar	48 Jars	1.06
SRH1434J	78103558070	1/4-20	3/4	100	Jar	48 Jars	1.27
SRH141J	78103558071	1/4-20	1	100	Jar	48 Jars	1.51
SRH14112J	78103558073	1/4-20	1-1/2	100	Jar	36 Jars	2.00
SRH142J	78103558075	1/4-20	2	100	Jar	36 Jars	2.49



Round Head Machine Screws • Slotted Brass^Δ

CATALOG NUMBER*	UPC NUMBER	DIAMETER	LENGTH	STD PAK [◇] PCS/PKG	PKG STYLE*	CASE QTY	WEIGHT/PKG (lbs.)
BRH634J	78103551316	6-32	3/4	100	Jar	48 Jars	0.32
BRH61J	78103551317	6-32	1	100	Jar	48 Jars	0.40
BRH6112J	78103551319	6-32	1-1/2	100	Jar	48 Jars	0.54
BRH62J	78103551321	6-32	2	100	Jar	48 Jars	0.86
BRH834J	78103551331	8-32	3/4	100	Jar	48 Jars	0.57
BRH81J	78103551332	8-32	1	100	Jar	48 Jars	0.60
BRH8112J	78103551334	8-32	1-1/2	100	Jar	48 Jars	0.87
BRH82J	78103551336	8-32	2	100	Jar	48 Jars	1.01
BRH1034J	78103551344	10-24	3/4	100	Jar	48 Jars	0.64
BRH101J	78103551345	10-24	1	100	Jar	48 Jars	0.83
BRH10112J	78103551347	10-24	1-1/2	100	Jar	48 Jars	1.13
BRH102J	78103551349	10-24	2	100	Jar	36 Jars	1.34
BRH134J	78103551360	10-32	3/4	100	Jar	48 Jars	0.66
BRH11J	78103551361	10-32	1	100	Jar	48 Jars	0.90
BRH1112J	78103551363	10-32	1-1/2	100	Jar	48 Jars	1.17
BRH12J	78103551364	10-32	2	100	Jar	36 Jars	1.51
BRH1412J	78103551368	1/4-20	1/2	100	Jar	48 Jars	1.03
BRH1434J	78103551370	1/4-20	3/4	100	Jar	48 Jars	1.38
BRH141J	78103551371	1/4-20	1	100	Jar	48 Jars	1.51
BRH14112J	78103551373	1/4-20	1-1/2	100	Jar	36 Jars	2.00
BRH142J	78103551375	1/4-20	2	100	Jar	36 Jars	2.49



^Δ Other sizes available upon request.

* Jar version part number shown. Box and Bulk versions may be available. Contact Selecta for availability, part number and pricing.

[◇] Other quantities per individual package may be available. Contact Selecta for details.

Machine Screw Kits • Round & Flat Head Packed in Reusable Plastic Box



CATALOG NUMBER	UPC NUMBER	MACHINE SCREWS CONTENTS DESCRIPTION	PKG STYLE	CASE QTY	WEIGHT/ PKG (lbs.)
AKFH632	78103522140	6 - 32 FLAT HEAD SLOTTED 100 - 3/4", 75 - 1", 75 - 1-1/4" 50 - 1-1/2", 40 - 2", 30 - 3"	Box	12 Boxes	1.86
AKRHC832	78103522145	8 - 32 ROUND HEAD COMBO 100 - 1/2", 75 - 3/4", 75 - 1" 50 - 1-1/4", 40 - 1-1/2", 30 - 2"	Box	12 Boxes	2.28
AKRHC1032	78103522147	10 - 32 ROUND HEAD COMBO 75 - 1/2", 50 - 3/4", 40 - 1" 30 - 1-1/4", 25 - 1-1/2", 25 - 2"	Box	12 Boxes	2.18
AKRHC1420	78103522149	1/4 - 20 ROUND HEAD COMBO 35 1 1/2", 30 - 3/4", 20 - 1" 15 - 1-1/4", 12 - 1-1/2", 12 - 2"	Box	12 Boxes	2.035

Machine Screws Mechanical & Performance Requirements



Description

A straight shank fastener for binding metal to metal by going through a hole or nut that is pre-tapped to form the same configuration as the screw.

Applications/ Advantages

Machine screws form a fastening superior in strength to spaced thread screws. Zinc yellow screws are popular in electronics applications. Stainless steel machine screws are used in applications which require general atmospheric corrosion resistance, in food processing machinery and refrigeration equipment. Stainless is also superior to steel in withstanding some elevation in application operating temperature while maintaining its strength.

◊ Other quantities per individual package may be available. Contact Selecta for details.

Hexagon Nuts Zinc-Plated Steel

CATALOG NO. N SERIES*	UPC NUMBER	CATALOG NO. N/G5 SERIES*	UPC NUMBER	SIZE	BOLT SIZE	STD PAK [◇] PCS/PKG	PKG STYLE*	CASE QTY	WEIGHT/ PKG (lbs.)
N632J	78103557005			6-32	1/8	100	Jar	48 Jars	0.28
N832J	78103557006			8-32	5/32	100	Jar	48 Jars	0.34
N1024J	78103557007			10-24	3/16	100	Jar	48 Jars	0.38
N1032J	78103557008			10-32	3/16	100	Jar	48 Jars	0.37
N1420J	78103557009	N1420G5J	78103557209	1/4-20	1/4	100	Jar	48 Jars	0.73
N51618J	78103557010	N51618G5J	78103557210	5/16-18	5/16	100	Jar	48 Jars	1.11
N3816J	78103557011	N3816G5J	78103557211	3/8-16	3/8	100	Jar	48 Jars	1.61
N1213J	78103557012	N1213G5J	78103557212	1/2-13	1/2	100	Jar	24 Jars	3.81
N5811J	78103557013	N5811G5J	78103557213	5/8-11	5/8	100	Jar	12 Jars	7.20
N3410J	78103557014	N3410G5J	78103557214	3/4-10	3/4	100	Jar	12 Jars	11.64



Hexagon Nuts 18-8 Stainless Steel

CATALOG NUMBER*	UPC NUMBER	SIZE	BOLT SIZE	STD PAK [◇] PCS/PKG	PKG STYLE*	CASE QTY	WEIGHT/ PKG (lbs.)
SHN632J	78103558405	6-32	1/8	100	Jar	48 Jars	0.22
SHN832J	78103558406	8-32	5/32	100	Jar	48 Jars	0.36
SHN1024J	78103558407	10-24	3/16	100	Jar	48 Jars	0.40
SHN1032J	78103558408	10-32	3/16	100	Jar	48 Jars	0.33
SHN1420J	78103558409	1/4-20	1/4	100	Jar	48 Jars	0.80
SHN51618J	78103558410	5/16-18	5/16	100	Jar	48 Jars	1.14
SHN3816J	78103558411	3/8-16	3/8	100	Jar	48 Jars	1.56
SHN1213J	78103558412	1/2-13	1/2	100	Jar	24 Jars	3.64



Hexagon Nuts Silicon Bronze

CATALOG NUMBER*	UPC NUMBER	SIZE	BOLT SIZE	STD PAK [◇] PCS/PKG	PKG STYLE*	CASE QTY	WEIGHT/ PKG (lbs.)
SBN1420J	78103558709	1/4-20	1/4	100	Jar	48 Jars	0.73
SBN51618J	78103558710	5/16-18	5/16	100	Jar	48 Jars	1.25
SBN3816J	78103558711	3/8-16	3/8	100	Jar	48 Jars	1.74
SBN1213J	78103558712	1/2-13	1/2	100	Jar	24 Jars	4.10



Hexagon Nuts Brass

CATALOG NUMBER*	UPC NUMBER	SIZE	BOLT SIZE	STD PAK [◇] PCS/PKG	PKG STYLE*	CASE QTY	WEIGHT/ PKG (lbs.)
BN632J	78103557102	6-32	1/8	100	Jar	48 Jars	0.22
BN832J	78103557104	8-32	5/32	100	Jar	48 Jars	0.31
BN1024J	78103557105	10-24	3/16	100	Jar	48 Jars	0.36
BN1032J	78103557106	10-32	3/16	100	Jar	48 Jars	0.38
BN1420J	78103557107	1/4-20	1/4	100	Jar	48 Jars	0.80
BN51618J	78103557109	5/16-18	5/16	100	Jar	48 Jars	1.26
BN3816J	78103557111	3/8-16	3/8	100	Jar	48 Jars	1.73
BN1213J	78103557113	1/2-13	1/2	100	Jar	24 Jars	2.37



* Jar version part number shown. Box and Bulk versions may be available. Contact Selecta for availability, part number and pricing.
[◇] Other quantities per individual package may be available. Contact Selecta for details.

Hexagon Lock Nuts With External Lock Washer Zinc-Plated Steel



CATALOG NUMBER*	UPC NUMBER	SIZE	BOLT SIZE	STD PAK [◇] PCS/PKG	PKG STYLE*	CASE QTY	WEIGHT/PKG (lbs.)
TN632J	78103557035	6-32	1/8	100	Jar	48 Jars	0.28
TN832J	78103557036	8-32	5/32	100	Jar	48 Jars	0.35
TN1024J	78103557037	10-24	3/16	100	Jar	48 Jars	0.39
TN1032J	78103557038	10-32	3/16	100	Jar	48 Jars	0.40
TN1420J	78103557039	1/4-20	1/4	100	Jar	48 Jars	0.74
TN51618J	78103557040	5/16-18	5/16	100	Jar	48 Jars	1.17
TN3816J	78103557041	3/8-16	3/8	100	Jar	48 Jars	1.77

Nylon Insert Lock Nuts Zinc-Plated Steel



CATALOG NUMBER*	UPC NUMBER	SIZE	BOLT SIZE	STD PAK [◇] PCS/PKG	PKG STYLE*	CASE QTY	WEIGHT/PKG (lbs.)
LN632J	78103557026	6-32	1/8	100	Jar	48 Jars	0.34
LN832J	78103557027	8-32	5/32	100	Jar	48 Jars	0.48
LN1024J	78103557028	10-24	3/16	100	Jar	48 Jars	0.55
LN1032J	78103557029	10-32	3/16	100	Jar	48 Jars	0.53
LN1420J	78103557030	1/4-20	1/4	100	Jar	48 Jars	0.95
LN51618J	78103557031	5/16-18	5/16	100	Jar	48 Jars	1.14
LN3816J	78103557032	3/8-16	3/8	100	Jar	48 Jars	1.79
LN1213J	78103557033	1/2-13	1/2	100	Jar	12 Jars	4.43

Wing Nuts • Forged Steel Zinc-Plated



CATALOG NUMBER*	UPC NUMBER	SIZE	BOLT SIZE	STD PAK [◇] PCS/PKG	PKG STYLE*	CASE QTY	WEIGHT/PKG (lbs.)
WN632J	78103557017	6-32	1/8	100	Jar	48 Jars	0.80
WN832J	78103557018	8-32	5/32	100	Jar	48 Jars	0.86
WN1024J	78103557019	10-24	3/16	100	Jar	48 Jars	0.92
WN1032J	78103557020	10-32	3/16	100	Jar	48 Jars	0.92
WN1420J	78103557021	1/4-20	1/4	100	Jar	48 Jars	1.28
WN51618J	78103557022	5/16-18	5/16	100	Jar	36 Jars	1.79
WN3816J	78103557023	3/8-16	3/8	100	Jar	24 Jars	3.26
WN1213J	78103557024	1/2-13	1/2	100	Jar	24 Jars	3.40

Hexagon Nut Kit • Zinc-Plated Steel Packed in Reusable Plastic Box



CATALOG NUMBER	UPC NUMBER	CONTENTS DESCRIPTION	PKG STYLE	CASE QTY	WEIGHT/PKG (lbs.)
AKHN	78103522150	100-6-32, 100-8-32, 100-10-32 50-1/4-20, 30-5/16-18, 20-3/8-16	Box	24 Boxes	1.96

+ Jar version part number shown. Box and Bulk versions may be available. Contact Selecta for availability, part number and pricing.
[◇] Other quantities per individual package may be available. Contact Selecta for details.

Flat SAE Washers Zinc Chromate Steel

CATALOG NUMBER*	UPC NUMBER	SIZE	BOLT SIZE	STD PAK [◇] PCS/PKG	PKG STYLE*	CASE QTY	WEIGHT/PKG (lbs.)
SAE6J	78103556013	6	1/8	100	Jar	48 Jars	0.19
SAE8J	78103556014	8	5/32	100	Jar	48 Jars	0.21
SAE10J	78103556015	10	3/16	100	Jar	48 Jars	0.25
SAE14J	78103556016	1/4	1/4	100	Jar	48 Jars	0.51
SAE516J	78103556017	5/16	5/16	100	Jar	48 Jars	0.61
SAE38J	78103556018	3/8	3/8	100	Jar	48 Jars	0.80
SAE12J	78103556019	1/2	1/2	100	Jar	48 Jars	1.80
SAE58J	78103556020	5/8	5/8	100	Jar	36 Jars	2.71
SAE34J	78103556021	3/4	3/4	100	Jar	12 Jars	4.25



18-8 Stainless Steel

SSAE6J	78103558213	6	1/8	100	Jar	48 Jars	0.10
SSAE8J	78103558214	8	5/32	100	Jar	48 Jars	0.16
SSAE10J	78103558215	10	3/16	100	Jar	48 Jars	0.24
SSAE14J	78103558216	1/4	1/4	100	Jar	48 Jars	0.33
SSAE516J	78103558217	5/16	5/16	100	Jar	48 Jars	0.45
SSAE38J	78103558218	3/8	3/8	100	Jar	48 Jars	0.63
SSAE12J	78103558219	1/2	1/2	100	Jar	48 Jars	1.64



Silicon Bronze

SBW14J	78103558816	1/4	1/4	100	Jar	48 Jars	0.43
SBW516J	78103558887	5/16	5/16	100	Jar	48 Jars	0.68
SBW38J	78103558818	3/8	3/8	100	Jar	48 Jars	0.93
SBW12J	78103558819	1/2	1/2	100	Jar	48 Jars	2.41

Split Lock Washers Zinc Chromate Steel

CATALOG NUMBER*	UPC NUMBER	SIZE	BOLT SIZE	STD PAK [◇] PCS/PKG	PKG STYLE*	CASE QTY	WEIGHT/PKG (lbs.)
LW6J	78103556028	6	1/8	100	Jar	48 Jars	0.11
LW8J	78103556029	8	5/32	100	Jar	48 Jars	0.13
LW10J	78103556030	10	3/16	100	Jar	48 Jars	0.15
LW14J	78103556031	1/4	1/4	100	Jar	48 Jars	0.29
LW516J	78103556032	5/16	5/16	100	Jar	48 Jars	0.44
LW38J	78103556033	3/8	3/8	100	Jar	48 Jars	0.68
LW12J	78103556034	1/2	1/2	100	Jar	48 Jars	1.34



18-8 Stainless Steel

SLW6J	78103558328	6	1/8	100	Jar	48 Jars	0.10
SLW8J	78103558329	8	5/32	100	Jar	48 Jars	0.12
SLW10J	78103558330	10	3/16	100	Jar	48 Jars	0.15
SLW14J	78103558331	1/4	1/4	100	Jar	48 Jars	0.29
SLW516J	78103558332	5/16	5/16	100	Jar	48 Jars	0.42
SLW38J	78103558333	3/8	3/8	100	Jar	48 Jars	0.63
SLW12J	78103558334	1/2	1/2	100	Jar	48 Jars	1.25



Silicon Bronze

SBLW14J	78103558916	1/4	1/4	100	Jar	48 Jars	0.34
SBLW516J	78103558917	5/16	5/16	100	Jar	48 Jars	0.48
SBLW38J	78103558918	3/8	3/8	100	Jar	48 Jars	0.77
SBLW12J	78103558919	1/2	1/2	100	Jar	48 Jars	1.50



+ Jar version part number shown. Box and Bulk versions may be available. Contact Selecta for availability, part number and pricing.
[◇] Other quantities per individual package may be available. Contact Selecta for details.

Flat Wrought USS Washers Steel, Zinc Chromate



CATALOG NUMBER*	UPC NUMBER	SIZE	BOLT SIZE	STD PAK [◇] PCS/PKG	PKG STYLE*	CASE QTY	WEIGHT/PKG (lbs.)
USS14J	78103556023	1/4 X 3/4	1/4	100	Jar	48 Jars	0.64
USS516J	78103556024	5/16 X 7/8	5/16	100	Jar	48 Jars	1.29
USS38J	78103556025	3/8 X 1	3/8	100	Jar	48 Jars	1.15
USS12J	78103556026	1/2 X 1-3/8	1/2	100	Jar	24 Jars	3.37
USS58J	78103556027	5/8 X 1-3/4	5/8	100	Jar	24 Jars	6.95
USS34J	78103556022	3/4 X 2	3/4	50	Jar	24 Jars	4.73

Fender Washers Steel, Zinc Chromate



CATALOG NUMBER*	UPC NUMBER	SIZE	BOLT SIZE	STD PAK [◇] PCS/PKG	PKG STYLE*	CASE QTY	WEIGHT/PKG (lbs.)
FW3161J	78103555995	3/16 X 1	3/16	100	Jar	48 Jars	1.42
FW316114J	78103555996	3/16 X 1-1/4	3/16	100	Jar	48 Jars	2.39
FW141J	78103556003	1/4 X 1	1/4	100	Jar	48 Jars	1.32
FW14114J	78103556004	1/4 X 1-1/4	1/4	100	Jar	48 Jars	2.10
FW14112J	78103556005	1/4 X 1-1/2	1/4	100	Jar	36 Jars	2.92
FW142J	78103556001	1/4 X 2	1/4	100	Jar	12 Jars	5.41
FW516114J	78103556006	5/16 X 1-1/4	5/16	100	Jar	48 Jars	2.11
FW516112J	78103556007	5/16 X 1-1/2	5/16	100	Jar	36 Jars	3.21
FW381J	78103556000	3/8 X 1	3/8	100	Jar	48 Jars	1.18
FW38114J	78103556008	3/8 X 1-1/4	3/8	100	Jar	48 Jars	1.73
FW38112J	78103556009	3/8 X 1-1/2	3/8	100	Jar	36 Jars	2.64
FW382J	78103556002	3/8 X 2	3/8	100	Jar	12 Jars	5.15
FW12112J	78103556010	1/2 X 1-1/2	1/2	100	Jar	36 Jars	2.76
FW122J	78103556011	1/2 X 2	1/2	100	Jar	12 Jars	5.26

Fender Washers Stainless Steel



CATALOG NUMBER*	UPC NUMBER	SIZE	BOLT SIZE	STD PAK [◇] PCS/PKG	PKG STYLE*	CASE QTY	WEIGHT/PKG (lbs.)
SFW141J	78103556110	1/4 X 1	1/4	100	Jar	48 Jars	1.01
SFW14114J	78103556111	1/4 X 1-1/4	1/4	100	Jar	48 Jars	1.49
SFW14112J	78103556112	1/4 X 1-1/2	1/4	100	Jar	48 Jars	2.29
SFW38114J	78103556113	3/8 X 1-1/4	3/8	100	Jar	48 Jars	1.53
SFW38112J	78103556114	3/8 X 1-1/2	3/8	100	Jar	36 Jars	2.65
SFW12112J	78103556115	1/2 X 1-1/2	1/2	100	Jar	36 Jars	2.59
SFW122J	78103556116	1/2 X 2	1/2	100	Jar	24 Jars	4.79

Belleville Washers Stainless Steel



CATALOG NUMBER*	UPC NUMBER	SIZE	BOLT SIZE	STD PAK [◇] PCS/PKG	PKG STYLE*	CASE QTY	WEIGHT/PKG (lbs.)
SSBW12J	78103556100	1/2 X 1-1/4 X .060	1/2	100	Jar	48 Jars	1.02
SSBW12THKJ	78103556101	1/2 X 1-1/4 X .125	1/2	100	Jar	24 Jars	3.51

* Jar version part number shown. Box and Bulk versions may be available. Contact Selecta for availability, part number and pricing.
[◇] Other quantities per individual package may be available. Contact Selecta for details.

Reducing Washers Galvanized Steel

CATALOG NUMBER*	UPC NUMBER	SIZE	STD PAK [◇] PCS/PKG	PKG STYLE*	CASE QTY	WEIGHT/PKG (lbs.)
RW3412J	78103556036	3/4 X 1/2	100	Jar	48 Jars	0.87
RW112J	78103556037	1 X 1/2	100	Jar	36 Jars	1.37
RW134J	78103556038	1 X 3/4	100	Jar	36 Jars	1.21
RW11412J	78103556039	1-1/4 X 1/2	100	Jar	24 Jars	2.60
RW11434J	78103556040	1-1/4 X 3/4	100	Jar	12 Jars	2.40
RW1141J	78103556041	1-1/4 X 1	100	Jar	24 Jars	1.75
RW11212J	78103556042	1-1/2 X 1/2	50	Jar	48 Jars	2.20
RW11234J	78103556043	1-1/2 X 3/4	50	Jar	48 Jars	2.11
RW1121J	78103556044	1-1/2 X 1	50	Jar	36 Jars	2.01
RW112114J	78103556045	1-1/2 X 1-1/4	50	Jar	36 Jars	1.53
RW212J	78103556046	2 X 1/2	50	Jar	12 Jars	4.09
RW234J	78103556047	2 X 3/4	50	Jar	12 Jars	2.98
RW21J	78103556048	2 X 1	50	Jar	12 Jars	3.30
RW2114J	78103556049	2 X 1-1/4	50	Jar	12 Jars	2.85
RW2112J	78103556050	2 X 1-1/2	50	Jar	12 Jars	2.50



Flat & Lock Washer Kits Packed in Reusable Plastic Box

CATALOG NUMBER	UPC NUMBER	FLAT & LOCK WASHER KITS CONTENTS DESCRIPTION	PKG STYLE	WEIGHT/PKG (lbs.)
AKSAE	78103522160	FLAT SAE WASHERS	Box	1.75
		100 - #6		
		100 - #8		
		100 - #10		
		75 - 1/4"		
		35 - 3/8"		
25 - 1/2"				
AKLW	78103522170	MEDIUM SPLIT LOCK WASHERS	Box	1.38
		100 - #8		
		100 - #10		
		100 - 1/4"		
		60 - 5/16"		
		40 - 3/8"		
25 - 1/2"				



* Jar version part number shown. Box and Bulk versions may be available. Contact Selecta for availability, part number and pricing.
[◇] Other quantities per individual package may be available. Contact Selecta for details.

Washers • Mechanical & Performance Requirements

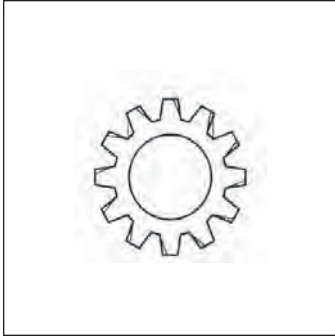

Description A hardened circular washer with twisted prongs or “teeth” which extend out from the outer edge of the washer.

Applications/ Advantages This is the most preferable of all tooth-lock washers. It offers the greatest locking efficiency since the teeth are on the largest radius and provide greater torsional resistance.

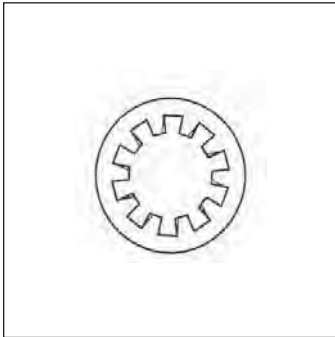

Description A hardened circular washer with twisted prongs or “teeth” which extend inward from the inside edge of the washer.

Applications/ Advantages This is preferred when finished appearance is crucial and the teeth must be hidden under the head of the screw; also recommended for use with small heads such as fillisters.

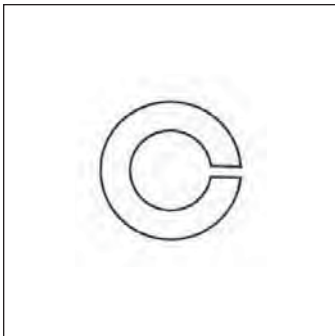

Regular & High-Alloy Split

Description **Regular:** A coiled, hardened, split washer with a slightly trapezoidal wire section.

High-Alloy: Dimensionally identical to a regular split lock washer but made from 4037 alloy steel.

Stainless: A regular split lock washer made from austenitic stainless steel.

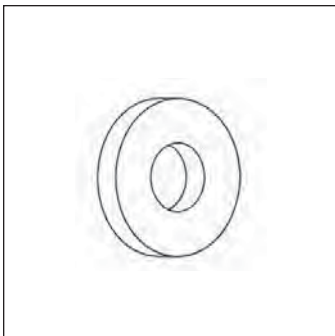

USS Flat

Description A thin, flat, circular steel part with a centrally located hole.

Applications/ Advantages Washers are designed for assembly around a bolt or screw, between the bearing surface of the fastener and the part to which it is attached. Flat washers are used to improve stress distribution, and to span large clearance holes. USS washers are designed to meet the majority of industrial applications in manufacturing, maintenance and repair.

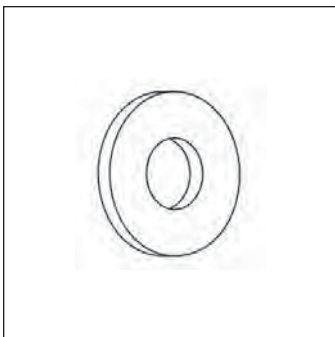

SAE Flat

Description Similar to a USS washer, but with slightly smaller inside and outside diameters. Also, most but not all SAE washers are made from thinner materials than USS washers.

Applications/ Advantages SAE washers were designed to serve similar purposes as the USS washers, but specifically to meet the requirements in the field of automotive engineering.

Pan Head Combo • Slotted/Phillips Tapping Screws Zinc-Plated Steel

CATALOG NUMBER*	UPC NUMBER	DIAMETER	LENGTH	STD PAK [◇] PCS/PKG	PKG STYLE†	CASE QTY	WEIGHT/PKG (lbs.)
TS412J	78103550003	4	1/2	100	Jar	48 Jars	0.20
TS434J	78103550005	4	3/4	100	Jar	48 Jars	0.23
TS41J	78103550006	4	1	100	Jar	48 Jars	0.31
* TS614J	78103550007	6	1/4	100	Jar	48 Jars	0.21
TS638J	78103550008	6	3/8	100	Jar	48 Jars	0.25
TS612J	78103550009	6	1/2	100	Jar	48 Jars	0.28
TS634J	78103550011	6	3/4	100	Jar	48 Jars	0.34
TS61J	78103550012	6	1	100	Jar	48 Jars	0.35
TS6114J	78103550013	6	1-1/4	100	Jar	48 Jars	0.50
TS6112J	78103550014	6	1-1/2	100	Jar	48 Jars	0.55
TS62J	78103550015	6	2	100	Jar	48 Jars	0.68
TS838J	78103550023	8	3/8	100	Jar	48 Jars	0.35
TS812J	78103550024	8	1/2	100	Jar	48 Jars	0.35
TS834J	78103550026	8	3/4	100	Jar	48 Jars	0.48
TS81J	78103550027	8	1	100	Jar	48 Jars	0.57
TS8114J	78103550028	8	1-1/4	100	Jar	48 Jars	0.66
TS8112J	78103550029	8	1-1/2	100	Jar	48 Jars	0.78
TS82J	78103550031	8	2	100	Jar	48 Jars	0.95
TS8212J	78103550032	8	2-1/2	100	Jar	36 Jars	1.15
TS1012J	78103550033	10	1/2	100	Jar	48 Jars	0.54
* TS1058J	78103550034	10	5/8	100	Jar	48 Jars	0.58
TS1034J	78103550035	10	3/4	100	Jar	48 Jars	0.61
TS101J	78103550036	10	1	100	Jar	48 Jars	0.79
TS10114J	78103550037	10	1-1/4	100	Jar	48 Jars	0.85
TS10112J	78103550038	10	1-1/2	100	Jar	48 Jars	1.00
TS10134J	78103550039	10	1-3/4	100	Jar	48 Jars	1.15
TS102J	78103550040	10	2	100	Jar	36 Jars	1.22
TS10212J	78103550041	10	2-1/2	100	Jar	24 Jars	1.49
TS103J	78103550042	10	3	100	Jar	36 Jars	1.78
TS1212J	78103550043	12	1/2	100	Jar	48 Jars	0.69
TS1234J	78103550045	12	3/4	100	Jar	48 Jars	0.85
TS121J	78103550046	12	1	100	Jar	48 Jars	1.03
TS12114J	78103550047	12	1-1/4	100	Jar	48 Jars	1.12
TS12112J	78103550048	12	1-1/2	100	Jar	48 Jars	1.36
TS122J	78103550050	12	2	100	Jar	24 Jars	1.70
TS12212J	78103550052	12	2-1/2	100	Jar	36 Jars	2.02
TS123J	78103550054	12	3	100	Jar	12 Jars	2.37
TS1412J	78103550090	14	1/2	100	Jar	48 Jars	0.91
TS1434J	78103550055	14	3/4	100	Jar	48 Jars	1.13
TS141J	78103550056	14	1	100	Jar	48 Jars	1.37
TS14114J	78103550057	14	1-1/4	100	Jar	48 Jars	1.58
TS14112J	78103550058	14	1-1/2	100	Jar	36 Jars	1.90
TS142J	78103550060	14	2	100	Jar	24 Jars	2.29



* Sizes slotted only

† Jar version part number shown. Box and Bulk versions may be available. Contact Selecta for availability, part number and pricing.

◇ Other quantities per individual package may be available. Contact Selecta for details.

Pan Head • Slotted or Phillips[^] Tapping Screws 18-8 Stainless Steel



CATALOG NUMBER [*]	UPC NUMBER	DIAMETER	LENGTH	STD PAK [◇] PCS/PKG	PKG STYLE [*]	CASE QTY	WEIGHT/PKG (lbs.)
STS612J	78103550109	6	1/2	100	Jar	48 Jars	0.25
STS634J	78103550111	6	3/4	100	Jar	48 Jars	0.29
STS61J	78103550112	6	1	100	Jar	48 Jars	0.38
STS812J	78103550124	8	1/2	100	Jar	48 Jars	0.38
STS834J	78103550126	8	3/4	100	Jar	48 Jars	0.47
STS81J	78103550127	8	1	100	Jar	48 Jars	0.56
STS8114J	78103550128	8	1-1/4	100	Jar	48 Jars	0.64
STS8112J	78103550129	8	1-1/2	100	Jar	48 Jars	0.78
STS82J	78103550131	8	2	100	Jar	48 Jars	0.90
STS1012J	78103550133	10	1/2	100	Jar	48 Jars	0.54
STS1034J	78103550135	10	3/4	100	Jar	48 Jars	0.60
STS101J	78103550136	10	1	100	Jar	48 Jars	0.70
STS10114J	78103550137	10	1-1/4	100	Jar	48 Jars	0.91
STS10112J	78103550138	10	1-1/2	100	Jar	48 Jars	0.97
STS102J	78103550140	10	2	100	Jar	48 Jars	1.28
STS1212J	78103550143	12	1/2	100	Jar	48 Jars	0.69
STS1234J	78103550145	12	3/4	100	Jar	48 Jars	0.85
STS121J	78103550146	12	1	100	Jar	48 Jars	0.98

Pan Head • Square Drive Tapping Screws Zinc-Plated Steel



CATALOG NUMBER [*]	UPC NUMBER	DIAMETER	LENGTH	STD PAK [◇] PCS/PKG	PKG STYLE [*]	CASE QTY	WEIGHT/PKG (lbs.)
TSS612J	78103550209	6	1/2	100	Jar	48 Jars	0.27
TSS634J	78103550211	6	3/4	100	Jar	48 Jars	0.33
TSS61J	78103550212	6	1	100	Jar	48 Jars	0.40
TSS6114J	78103550213	6	1-1/4	100	Jar	48 Jars	0.43
TSS6112J	78103550214	6	1-1/2	100	Jar	48 Jars	0.54
TSS62J	78103550215	6	2	100	Jar	48 Jars	0.66
TSS812J	78103550224	8	1/2	100	Jar	48 Jars	0.40
TSS834J	78103550226	8	3/4	100	Jar	48 Jars	0.48
TSS81J	78103550227	8	1	100	Jar	48 Jars	0.59
TSS8114J	78103550228	8	1-1/4	100	Jar	48 Jars	0.65
TSS8112J	78103550229	8	1-1/2	100	Jar	48 Jars	0.78
TSS82J	78103550231	8	2	100	Jar	48 Jars	0.94
TSS1012J	63290913592	10	1/2	100	Jar	48 Jars	0.54
TSS1034J	78103550235	10	3/4	100	Jar	48 Jars	0.68
TSS101J	78103550236	10	1	100	Jar	48 Jars	0.81
TSS10114J	78103550237	10	1-1/4	100	Jar	48 Jars	0.90
TSS10112J	78103550238	10	1-1/2	100	Jar	48 Jars	1.03
TSS102J	78103550240	10	2	100	Jar	36 Jars	1.26
TSS10212J	78103550241	10	2-1/2	100	Jar	36 Jars	1.55
TSS103J	78103550242	10	3	100	Jar	24 Jars	1.75
TSS1234J	78103550245	12	3/4	100	Jar	48 Jars	0.80
TSS121J	78103550246	12	1	100	Jar	48 Jars	1.00
TSS12114J	78103550247	12	1-1/4	100	Jar	48 Jars	1.23
TSS12112J	78103550248	12	1-1/2	100	Jar	48 Jars	1.38
TSS122J	78103550250	12	2	100	Jar	24 Jars	1.75
TSS12212J	78103550251	12	2-1/2	100	Jar	24 Jars	2.10
TSS123J	78103550254	12	3	100	Jar	12 Jars	2.22

[^] Add "P" to part Number for Phillips (example: STSP612)

^{*} Jar version part number shown. Box and Bulk versions may be available. Contact Selecta for availability, part number and pricing.

[◇] Other quantities per individual package may be available. Contact Selecta for details.

Hex Washer Head Slotted Tapping Screws Zinc-Plated Steel

CATALOG NUMBER [*]	UPC NUMBER	DIAMETER	LENGTH	STD PAK [◇] PCS/PKG	PKG STYLE [*]	CASE QTY	WEIGHT/PKG (lbs.)
1/4" HEX HEAD USE DSC14 CHUCK PAGE K-4							
DS612J	78103552011	6	1/2	100	Jar	48 Jars	0.31
DS634J	78103552012	6	3/4	100	Jar	48 Jars	0.36
DS61J	78103552013	6	1	100	Jar	48 Jars	0.45
DS6114J	78103552014	6	1-1/4	100	Jar	48 Jars	0.45
DS6112J	78103552015	6	1-1/2	100	Jar	48 Jars	0.60
DS812J	78103552018	8	1/2	100	Jar	48 Jars	0.39
DS834J	78103552019	8	3/4	100	Jar	48 Jars	0.46
DS81J	78103552020	8	1	100	Jar	48 Jars	0.58
DS8114J	78103552021	8	1-1/4	100	Jar	48 Jars	0.69
DS8112J	78103552022	8	1-1/2	100	Jar	48 Jars	0.76
DS82J	78103552023	8	2	100	Jar	36 Jars	1.00
5/16" HEX HEAD USE DSC516 CHUCK PAGE K-4							
DS1012J	78103552024	10	1/2	100	Jar	48 Jars	0.54
* DS1034J	78103552025	10	3/4	100	Jar	48 Jars	0.67
* DS101J	78103552026	10	1	100	Jar	48 Jars	0.91
* DS10114J	78103552027	10	1-1/4	100	Jar	48 Jars	0.87
* DS10112J	78103552028	10	1-1/2	100	Jar	48 Jars	1.01
* DS102J	78103552029	10	2	100	Jar	36 Jars	1.22
DS10212J	78103552031	10	2-1/2	100	Jar	24 Jars	1.49
DS103J	78103552033	10	3	100	Jar	12 Jars	1.78
DS1212J	78103552100	12	1/2	100	Jar	48 Jars	0.67
DS1234J	78103552101	12	3/4	100	Jar	48 Jars	0.79
DS121J	78103552102	12	1	100	Jar	48 Jars	0.99
DS12114J	78103552103	12	1-1/4	100	Jar	48 Jars	1.00
DS12112J	78103552104	12	1-1/2	100	Jar	36 Jars	1.31
DS122J	78103552106	12	2	100	Jar	24 Jars	1.68
DS12212J	78103552108	12	2-1/2	100	Jar	24 Jars	2.02
DS123J	78103552110	12	3	100	Jar	12 Jars	2.34
3/8" HEX HEAD USE DSC38 CHUCK PAGE K-4							
DS1434J	78103552035	14	3/4	100	Jar	48 Jars	1.25
DS141J	78103552036	14	1	100	Jar	48 Jars	1.47
DS14114J	78103552037	14	1-1/4	100	Jar	36 Jars	1.75
DS14112J	78103552038	14	1-1/2	100	Jar	24 Jars	2.01
DS142J	78103552039	14	2	100	Jar	24 Jars	2.42



Quik Drill/High Performance • Hex Washer Head[√] Combo Slotted/Phillips Screws • Zinc-Plated Steel

CATALOG NUMBER [*]	UPC NUMBER	DIAMETER	LENGTH	HEAD SIZE	STD PAK [◇] PCS/PKG	PKG STYLE [*]	CASE QTY	WEIGHT/PKG (lbs.)
QD712-1/4J	78103552200	7	1/2	1/4	100	Jar	48 Jars	0.32
QD812-1/4J	78103552201	8	1/2	1/4	100	Jar	48 Jars	0.37
QD834-1/4J	78103552202	8	3/4	1/4	100	Jar	48 Jars	0.45
QD81-1/4J	78103552203	8	1	1/4	100	Jar	48 Jars	0.54
QD8112-1/4J	78103552204	8	1-1/2	1/4	100	Jar	48 Jars	0.72
QD82-1/4J	78103552205	8	2	1/4	100	Jar	36 Jars	0.91
QD1012-1/4J	78103552206	10	1/2	1/4	100	Jar	48 Jars	0.45
QD1012-5/16J	78103552206	10	1/2	5/16	100	Jar	48 Jars	0.49
QD1034-1/4J	78103552207	10	3/4	1/4	100	Jar	48 Jars	0.56
QD1034-5/16J	78103552207	10	3/4	5/16	100	Jar	48 Jars	0.63
QD101-1/4J	78103552208	10	1	1/4	100	Jar	48 Jars	0.63
QD101-5/16J	78103552208	10	1	5/16	100	Jar	48 Jars	0.65
QD10112-1/4J	78103512209	10	1-1/2	1/4	100	Jar	48 Jars	0.88
QD10112-5/16J	78103552209	10	1-1/2	5/16	100	Jar	48 Jars	1.00
QD102-1/4J	78103552210	10	2	1/4	100	Jar	36 Jars	1.21
QD102-5/16J	78103552210	10	2	5/16	100	Jar	36 Jars	1.26



* These sizes are combo slot/phillips head

[√] Jar version part number shown. Box and Bulk versions may be available. Contact Selecta for availability, part number and pricing.

[◇] Other quantities per individual package may be available. Contact Selecta for details.

[√] 1/4 Hex Head, use DSC14 Chuck, page K-4. 5/16 Hex Head, use DSC516 Chuck on page K-4.

Hex Washer Head TEK Drill Screws Steel, Zinc Chromate



CATALOG NUMBER*	UPC NUMBER	DIAMETER	LENGTH	STD PAK [◇] PCS/PKG	PKG STYLE*	CASE QTY	WEIGHT/PKG (lbs.)
#2 POINT, 1/4" HEX HEAD, USE DSC14 CHUCK, PAGE K-4							
TK812J	78103552050	8	1/2	100	Jar	48 Jars	0.39
TK834J	78103552051	8	3/4	100	Jar	48 Jars	0.49
TK81J	78103552052	8	1	100	Jar	48 Jars	0.57
TK8114J	78103552054	8	1-1/4	100	Jar	48 Jars	0.67
TK8112J	78103552053	8	1-1/2	100	Jar	48 Jars	0.80
#2 POINT, 5/16" HEX HEAD, USE DSC516 CHUCK, PAGE K-4							
TK1012J	78103552056	10	1/2	100	Jar	48 Jars	0.53
#3 POINT, 5/16" HEX HEAD, USE DSC516 CHUCK, PAGE K-4							
TK1034J	78103552057	10	3/4	100	Jar	48 Jars	0.64
TK101J	78103552058	10	1	100	Jar	48 Jars	0.74
TK10114J	78103552059	10	1-1/4	100	Jar	48 Jars	0.88
TK10112J	78103552060	10	1-1/2	100	Jar	48 Jars	1.00
TK102J	78103552062	10	2	100	Jar	36 Jars	1.25
TK1234J	78103552064	12	3/4	100	Jar	48 Jars	0.82
TK121J	78103552066	12	1	100	Jar	48 Jars	0.95
TK12114J	78103552067	12	1-1/4	100	Jar	48 Jars	1.16
TK12112J	78103552068	12	1-1/2	100	Jar	48 Jars	1.33
TK122J	78103552069	12	2	100	Jar	36 Jars	1.61
#3 POINT, 3/8" HEX HEAD, USE DSC38 CHUCK, PAGE K-4							
TK1434J	78103552070	14	3/4	100	Jar	48 Jars	1.24
TK141J	78103552071	14	1	100	Jar	48 Jars	1.40
TK14114J	78103552072	14	1-1/4	100	Jar	36 Jars	1.70
TK14112J	78103552073	14	1-1/2	100	Jar	36 Jars	1.95

Pan Head • Phillips Drive Self Drilling Screws Zinc-Plated Steel



CATALOG NUMBER*	UPC NUMBER	DIAMETER	LENGTH	STD PAK [◇] PCS/PKG	PKG STYLE*	CASE QTY	WEIGHT/PKG (lbs.)
TKP638J	78103552224	6	3/8	100	Jar	48 Jars	0.27
TKP612J	78103552245	6	1/2	100	Jar	48 Jars	0.30
TKP61J	78103552246	6	1	100	Jar	48 Jars	0.41
TKP812J	78103552250	8	1/2	100	Jar	48 Jars	0.38
TKP834J	78103552251	8	3/4	100	Jar	48 Jars	0.48
TKP81J	78103552252	8	1	100	Jar	48 Jars	0.56
TKP1012J	78103552256	10	1/2	100	Jar	48 Jars	0.53
TKP1034J	78103552257	10	3/4	100	Jar	48 Jars	0.67
TKP101J	78103552258	10	1	100	Jar	48 Jars	0.80
TKP10114J	78103552259	10	1-1/4	100	Jar	48 Jars	0.89
TKP10112J	78103552260	10	1-1/2	100	Jar	48 Jars	0.99

Self Drilling Screw Kits Packed in Reusable Plastic Box



CATALOG NUMBER	UPC NUMBER	SHEET METAL SCREWS CONTENTS DESCRIPTION	PKG STYLE	WEIGHT/PKG (lbs.)
AKTKH810	78103522130	#8 - 10 HEX WASHER, 1-1/4" DRIVER, 1-5/16" DRIVER #8 - 100 - 1/2", 50 - 3/4", 40 - 1" #10 - 50 - 1/2", 35 - 3/4", 30 - 1"	Box	1.85
AKTKP810	78103522134	#8 - 10 PAN PHIL DRIVE, 1 - #2 PHILLIPS POWER BIT #8 - 100 - 1/2", 50 - 3/4", 50 - 1" #10 - 80 - 1/2", 50 - 3/4", 40 - 1"	Box	1.85
AKTKSQ810	78103522138	#8 - 10 PAN SQUARE DRIVE, 1 - #2 SQUARE POWER BIT #8 - 100 - 1/2", 60 - 3/4", 50 - 1" #10 - 80 - 1/2", 50 - 3/4", 40 - 1"	Box	1.18

* Jar version part number shown. Box and Bulk versions may be available. Contact Selecta for availability, part number and pricing.
[◇] Other quantities per individual package may be available. Contact Selecta for details.

Pan Head • Square Drive Self Drilling Screws Zinc-Plated Steel

CATALOG NUMBER*	UPC NUMBER	DIAMETER	LENGTH	STD PAK [◇] PCS/PKG	PKG STYLE*	CASE QTY	WEIGHT/PKG (lbs.)
TKSD812J	78103552150	8	1/2	100	Jar	48 Jars	0.38
TKSD834J	78103552151	8	3/4	100	Jar	48 Jars	0.46
TKSD81J	78103552152	8	1	100	Jar	48 Jars	0.57
TKSD1012J	78103552156	10	1/2	100	Jar	48 Jars	0.51
TKSD1058J	78103552155	10	5/8	100	Jar	48 Jars	0.57
TKSD1034J	78103552157	10	3/4	100	Jar	48 Jars	0.63
TKSD101J	78103552158	10	1	100	Jar	48 Jars	0.71
TKSD10114J	78103552159	10	1-1/4	100	Jar	48 Jars	0.96
TKSD10112J	78103552160	10	1-1/2	100	Jar	48 Jars	1.03
TKSD102J	78103552161	10	2	100	Jar	48 Jars	1.23



Flat Head • Phillips Tapping Screws Zinc-Plated Steel

CATALOG NUMBER*	UPC NUMBER	DIAMETER	LENGTH	STD PAK [◇] PCS/PKG	PKG STYLE*	CASE QTY	WEIGHT/PKG (lbs.)
TSF612J	78103550309	6	1/2	100	Jar	48 Jars	0.21
TSF634J	78103550311	6	3/4	100	Jar	48 Jars	0.28
TSF61J	78103550312	6	1	100	Jar	48 Jars	0.37
TSF6114J	78103550313	6	1-1/4	100	Jar	25 Jars	0.40
TSF6112J	78103550314	6	1-1/2	100	Jar	48 Jars	0.50
TSF62J	78103550315	6	2	100	Jar	48 Jars	0.62
TSF812J	78103550324	8	1/2	100	Jar	48 Jars	0.35
TSF834J	78103550326	8	3/4	100	Jar	48 Jars	0.41
TSF81J	78103550327	8	1	100	Jar	48 Jars	0.49
TSF8114J	78103550328	8	1-1/4	100	Jar	48 Jars	0.57
TSF8112J	78103550329	8	1-1/2	100	Jar	48 Jars	0.72
TSF82J	78103550331	8	2	100	Jar	48 Jars	0.90
TSF1034J	78103550335	10	3/4	100	Jar	48 Jars	0.52
TSF101J	78103550336	10	1	100	Jar	48 Jars	0.70
TSF10114J	78103550337	10	1-1/4	100	Jar	48 Jars	0.75
TSF10112J	78103550338	10	1-1/2	100	Jar	48 Jars	0.92
TSF102J	78103550340	10	2	100	Jar	36 Jars	1.27



Flat Head • Square Drive Tapping Screws Zinc-Plated Steel

CATALOG NUMBER*	UPC NUMBER	DIAMETER	LENGTH	STD PAK [◇] PCS/PKG	PKG STYLE*	CASE QTY	WEIGHT/PKG (lbs.)
TSFSD834J	78103550345	8	3/4	100	Jar	48 Jars	0.36
TSFSD81J	78103550346	8	1	100	Jar	48 Jars	0.46
TSFSD8114J	78103550347	8	1-1/4	100	Jar	48 Jars	0.59



* Jar version part number shown. Box and Bulk versions may be available. Contact Selecta for availability, part number and pricing.
[◇] Other quantities per individual package may be available. Contact Selecta for details.

Sheet Metal Screw Kits Packed in Reusable Plastic Box



CATALOG NUMBER	UPC NUMBER	SHEET METAL SCREWS CONTENTS DESCRIPTION	PKG STYLE	WEIGHT/ PKG (lbs.)
AKPC8	78103522100	#8 PAN HD COMBO, 1 - #2 PHILLIPS POWER BIT 100 - 1/2", 75 - 3/4", 50 - 1" 30 - 1-1/4", 25 - 1-1/2", 20 - 2"	Box	1.66
AKPC10	78103522101	#10 PAN HD COMBO, 1 - #2 PHILLIPS POWER BIT 75 - 1/2", 50 - 3/4", 45 - 1" 30 - 1-1/4", 25 - 1-1/2", 20 - 2"	Box	1.84
AKHWS8	78103522110	#8 HEX SLOT WASHER, 1-1/4" NUT DRIVER 100 - 1/2", 75 - 3/4", 45 - 1" 30 - 1-1/4", 25 - 1-1/2", 20 - 2"	Box	1.69
AKHWS10	78103522111	#10 HEX SLOT WASHER, 1-5/16" NUT DRIVER 75 - 1/2", 50 - 3/4", 45 - 1" 30 - 1-1/4", 25 - 1-1/2", 20 - 2"	Box	1.90
AKPSQ8	78103522120	#8 PAN HD SQUARE DRIVE, 1 - #2 SQUARE DRIVE BIT 100 - 1/2", 75 - 3/4", 50 - 1" 30 - 1-1/4", 25 - 1-1/2", 20 - 2"	Box	1.50
AKPSQ10	78103522121	#10 PAN HD SQUARE DRIVE, 1 - #2 SQUARE DRIVE BIT 75 - 1/2", 50 - 3/4", 45 - 1" 30 - 1-1/4", 25 - 1-1/2", 20 - 2"	Box	1.95

Extended Self-Drilling Fasteners



CATALOG NUMBER	UPC NUMBER	DIAMETER	LENGTH	STD PAK [◇] PCS/PKG	PKG STYLE	CASE QTY	WEIGHT/ PKG (lbs.)
TKED12114J	78103552290	12-24	1-1/4	100	Jar	48 Jars	1.10

Applications

- Metal deck to structural steel or bar joist
- Clips to structural steel or bar joist
- Liner panels to structural steel or bar joist
- Accessories to structural steel or bar joist
- Longer fasteners can be used in retrofit clip and sheet applications

Product Features

- Unique double fluted point has precise cutting edges to improve drill performance in 1/4" thru 1/2" steel
- Engineered for fast drilling and smooth tapping with less effort

Product Specifications

- Diameter: #12
- Thread Form: 12-24, 1/4-28
- Head Style: 5/16" HWH
- Mechanical Zinc Plating

+ Jar version part number shown. Box and Bulk versions may be available. Contact Selecta for availability, part number and pricing.
[◇] Other quantities per individual package may be available. Contact Selecta for details.

Mechanical & Performance Requirements

Self-Tapping Screws • Thread Forming • Type A

- Description** A thread forming tapping screw with wider spaced threads than a Type-AB and a gimlet point.
- Applications/Advantages** For self starting in thin (.015-.050 thick) metal or resin-filled plywood. 18-8 Stainless steel tapping screws may be used in applications which require general atmospheric corrosion resistance. Fastening stainless steel parts to aluminum or steel can cause a type of corrosion known as galvanic couple in some environments.

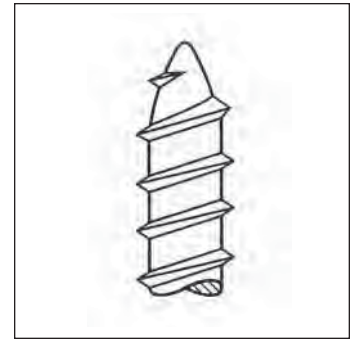

Self-Tapping Screws • Thread Forming • Type AB

- Description** A thread forming tapping screw with spaced threads and a gimlet point.
- Applications/Advantages** For self starting in thin metal or resin-filled plywood. Recommended over a Type-A, particularly in brittle materials.

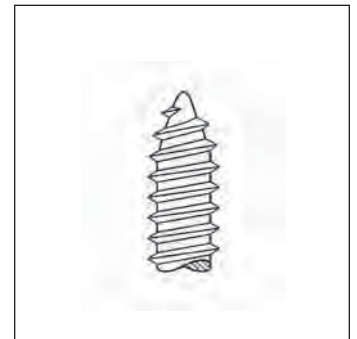

Self-Tapping Screws • Self-Piercing

- Description** A slotted hex washer head thread forming tapping screw with a single lead thread rolled to the tip of an extra sharp point, and a second thread spaced 180° apart.
- Applications/Advantages** May be used in thin metal (less than .050 thick). Eliminates need for pre-drilled or pre-punched holes. Undercut area beneath the head allows greater length of thread engagement. Twin lead threads help to reduce driving torque.

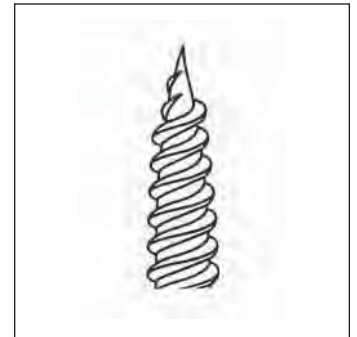

Black Phosphate Drywall Screws • Fine Thread Bugle Head Phillips • 20 Gauge Max Steel Stud

CATALOG NUMBER	UPC NUMBER	DIAMETER	LENGTH	STD PAK [◇] PCS/PKG	PKG STYLE [*]	CASE QTY	WEIGHT/PKG (lbs.)
DW61J	78103554004	6	1	100	Jar	48 Jars	0.34
DW61B	78103554005	6	1	10,000	Box	N/A	30.00
DW61MJ	78103554006	6	1	1,000	Jar	12 Jars	3.17
DW6114J	78103554007	6	1-1/4	100	Jar	48 Jars	0.43
DW6114B	78103554008	6	1-1/4	8,000	Box	N/A	29.35
DW6114MJ	78103554009	6	1-1/4	1,000	Jar	12 Jars	3.71
DW6158J	78103554010	6	1-5/8	100	Jar	48 Jars	0.49
DW6158B	78103554011	6	1-5/8	5,000	Box	N/A	23.45
DW6158MJ	78103554012	6	1-5/8	1,000	Jar	12 Jars	4.76
DW62J	78103554013	6	2	100	Jar	48 Jars	0.57
DW62B	78103554014	6	2	3,500	Box	N/A	21.35
DW62MJ	78103554015	6	2	1,000	Jar	12 Jars	6.10
DW6214J	78103554016	6	2-1/4	100	Jar	48 Jars	0.70
DW6214B	78103554017	6	2-1/4	3,000	Box	N/A	24.00
DW6214MJ	78103554018	6	2-1/4	1,000	Jar	N/A	6.40
DW8212J	78103554019	8	2-1/2	100	Jar	36 Jars	1.00
DW8212B	78103554022	8	2-1/2	2,500	Box	N/A	27.00
DW8212MJ	78103554021	8	2-1/2	1,000	Jar	N/A	10.40
DW83J	78103554020	8	3	100	Jar	24 Jars	1.17
DW83B	78103554023	8	3	2,000	Box	N/A	26.00
DW83MJ	78103554024	8	3	1,000	Jar	12 Jars	10.65



Dacrotized (DWG) • Zinc Plated & Yellow Chromate (DEK) Coarse Thread/Bugle Head Phillips

CATALOG NO. DWG [*]	UPC NUMBER	CATALOG NO. DEK [*]	UPC NUMBER	DIAMETER	LENGTH	STD PAK [◇] PCS/PKG	PKG STYLE [*]	CASE QTY	WEIGHT/PKG (lbs.)
DWG61J	78103554104	DEK61J	78103554130	6	1	100	Jar	48 Jars	0.37
DWG61B	78103514105	DEK61B	78103514131	6	1	10,000	Box	N/A	35.00
DWG61MJ	78103554106	DEK61MJ	78103554132	6	1	1,000	Jar	12 Jars	3.47
DWG6114J	78103554107	DEK6114J	78103554133	6	1-1/4	100	Jar	48 Jars	0.40
DWG6114B	78103514108	DEK6114B	78103514134	6	1-1/4	8,000	Box	N/A	32.8
DWG6114MJ	78103554109	DEK6114MJ	78103554135	6	1-1/4	1,000	Jar	12 Jars	3.67
DWG6158J	78103554110	DEK6158J	78103554136	6	1-5/8	100	Jar	48 Jars	0.50
DWG6158B	78103514111	DEK6158B	78103514137	6	1-5/8	5,000	Box	N/A	26.00
DWG6158MJ	78103554112	DEK6158MJ	78103554138	6	1-5/8	1,000	Jar	6 Jars	5.20
DWG62J	78103554113	DEK62J	78103554139	6	2	100	Jar	48 Jars	0.62
DWG62B	78103514114	DEK62B	78103514140	6	2	3,500	Box	N/A	25.90
DWG62MJ	78103554115	DEK62MJ	78103554141	6	2	1,000	Jar	6 Jars	5.59
DWG6214J	78103554116	DEK6214J	78103554142	6	2-1/4	100	Jar	48 Jars	0.70
DWG6214B	78103514117	DEK6214B	78103514143	6	2-1/4	3,000	Box	N/A	24.00
DWG6214MJ	78103554118	DEK6214MJ	78103554144	6	2-1/4	1,000	Jar	6 Jars	8.00
DWG8212J	78103554119	DEK8212J	78103554145	8	2-1/2	100	Jar	36 Jars	0.95
DWG8212B	78103514122	DEK8212B	78103514146	8	2-1/2	2,500	Box	N/A	27.00
DWG8212MJ	78103554121	DEK8212MJ	78103554147	8	2-1/2	1,000	Jar	6 Jars	9.35
DWG83J	78103554120	DEK83J	78103554148	8	3	100	Jar	24 Jars	1.15
DWG83B	78103514123	DEK83B	78103514149	8	3	2,000	Box	N/A	26.00
DWG83MJ	78103554124	DEK83MJ	78103554150	8	3	1,000	Jar	6 Jars	13.00



* Jar version part number shown. Box and Bulk versions may be available. Contact Selecta for availability, part number and pricing.
[◇] Other quantities per individual package may be available. Contact Selecta for details.

Black Phosphate Pan Framing Screws Phillips Drive • 20 Gauge Max Steel Stud



CATALOG NUMBER*	UPC NUMBER	DIAMETER	LENGTH	STD PAK [◇] PCS/PKG	PKG STYLE*	CASE QTY	WEIGHT/PKG (lbs.)
PDW6716J	78103554040	6	7/16	100	Jar	48 Jars	0.32
PDW6716B	78103514041	6	7/16	15,000	Box	N/A	39.75
PDW6716MJ	78103554042	6	7/16	1,000	Jar	12 Jars	2.23

Black Phosphate Stud Cutter Self-Drilling Drywall Screws Bugle Head Phillips • 12 Gauge Max Steel Stud



CATALOG NUMBER*	UPC NUMBER	DIAMETER	LENGTH	STD PAK [◇] PCS/PKG	PKG STYLE*	CASE QTY	WEIGHT/PKG (lbs.)
SC61J	78103554060	6	1	100	Jar	48 Jars	0.40
SC61B	78103514061	6	1	10,000	Box	N/A	31.00
SC61MJ	78103554062	6	1	1,000	Jar	12 Jars	3.47
SC6114J	78103554063	6	1-1/4	100	Jar	48 Jars	0.47
SC6114B	78103514064	6	1-1/4	8,000	Box	N/A	32.80
SC6114MJ	78103554065	6	1-1/4	1,000	Jar	12 Jars	3.67
SC6158J	78103554066	6	1-5/8	100	Jar	48 Jars	0.55
SC6158B	78103514067	6	1-5/8	5,000	Box	N/A	26.00
SC6158MJ	78103554068	6	1-5/8	1,000	Jar	12 Jars	5.20
SC8258J	78103554069	8	2-5/8	100	Jar	36 Jars	1.09
SC8258B	78103514070	8	2-5/8	2,000	Box	N/A	23.00
SC8258MJ	78103554071	8	2-5/8	1,000	Jar	12 Jars	10.49
SC83J	78103554072	8	3	100	Jar	24 Jars	1.32
SC83B	78103514073	8	3	2,000	Box	N/A	18.45
SC83MJ	78103557074	8	3	1,000	Jar	12 Jars	12.07

Zinc Plated Stud Cutter • Self-Drilling Pan Framing Phillips Drive • 12 Gauge Max Steel Stud



CATALOG NUMBER*	UPC NUMBER	DIAMETER	LENGTH	STD PAK [◇] PCS/PKG	PKG STYLE*	CASE QTY	WEIGHT/PKG (lbs.)
PSC6716J	78103554090	6	7/16	100	Jar	48 Jars	0.33
PSC6716B	78103514091	6	7/16	15,000	Box	N/A	42.30
PSC6716MJ	78103554092	6	7/16	1,000	Jar	36 Jars	2.61

Zinc Plated Stud Cutter • Self-Drilling • Wafer Head Phillips Drive • 12 Gauge Max Steel Stud



CATALOG NUMBER*	UPC NUMBER	DIAMETER	LENGTH	STD PAK [◇] PCS/PKG	PKG STYLE*	CASE QTY	WEIGHT/PKG (lbs.)
SCW812J	78103554081	8	1/2	100	Jar	48 Jars	0.43
SCW812B	78103514082	8	1/2	12,000	Box	N/A	41.56
SCW812MJ	78103554083	8	1/2	1,000	Jar	24 Jars	3.69
SCW834J	78103554084	8	3/4	100	Jar	48 Jars	0.52
SCW834B	78103514085	8	3/4	8,000	Box	N/A	36.70
SCW834MJ	78103554086	8	3/4	1,000	Jar	12 Jars	3.90
SCW81J	78103554087	8	1	100	Jar	48 Jars	0.56
SCW81B	78103514088	8	1	4,000	Box	N/A	31.60
SCW81MJ	78103554089	8	1	1,000	Jar	12 Jars	7.90

* Jar version part number shown. Box and Bulk versions may be available. Contact Selecta for availability, part number and pricing.
[◇] Other quantities per individual package may be available. Contact Selecta for details.

Zinc Plated Wafer Head Phillips Drive 20 Gauge Max Steel Stud

CATALOG NUMBER*	UPC NUMBER	DIAMETER	LENGTH	STD PAK [◇] PCS/PKG	PKG STYLE*	CASE QTY	WEIGHT/PKG (lbs.)
WHP812J	78103554050	8	1/2	100	Jar	48 Jars	0.36
WHP812B	78103514051	8	1/2	10,000	Box	N/A	36.95
WHP812MJ	78103554052	8	1/2	1,000	Jar	12 Jars	3.90
WHP834J	78103554056	8	3/4	100	Jar	48 Jars	0.51
WHP834MJ	78103551400	8	3/4	1,000	Jar	12 Jars	4.77
WHP834B	78103514057	8	3/4	10,000	Box	N/A	45.98
WHP81J	78103554053	8	1	100	Jar	48 Jars	0.59
WHP81MJ	78103551401	8	1	1,000	Jar	12 Jars	5.59
WHP81B	78103581402	8	1	8,000	Box	N/A	46.00



Flat Head Wood Screws • Slotted & Phillips[^] Zinc-Plated Steel

CATALOG NO. SLOTTED*	UPC NUMBER	CATALOG NO. PHILLIPS*	UPC NUMBER	DIAMETER	LENGTH	STD PAK [◇] PCS/PKG	PKG STYLE*	CASE QTY	WEIGHT/PKG (lbs.)
FS412J	78103553003	-		4	1/2	100	Jar	48 Jars	0.18
FS434J	78103553005	FP434J	78103553105	4	3/4	100	Jar	48 Jars	0.20
FS41J	78103553006	FP41J	78103553106	4	1	100	Jar	48 Jars	0.27
FS4114J	78103553007	FP4114J	78103553107	4	1-1/4	100	Jar	48 Jars	0.29
FS534J	78103553009	-		5	3/4	100	Jar	48 Jars	0.32
FS51J	78103553010	-		5	1	100	Jar	48 Jars	0.34
FS612J	78103553012	FP612J	78103553112	6	1/2	100	Jar	48 Jars	0.27
FS634J	78103553014	FP634J	78103553114	6	3/4	100	Jar	48 Jars	0.32
FS61J	78103553015	FP61J	78103553115	6	1	100	Jar	48 Jars	0.40
FS6114J	78103553016	FP6114J	78103553116	6	1-1/4	100	Jar	48 Jars	0.43
FS6112J	78103553017	FP6112J	78103553117	6	1-1/2	100	Jar	48 Jars	0.49
FS62J	78103553018	FP62J	78103553118	6	2	100	Jar	48 Jars	0.55
FS834J	78103553019	FP834J	78103553119	8	3/4	100	Jar	48 Jars	0.46
FS81J	78103553020	FP81J	78103553120	8	1	100	Jar	48 Jars	0.53
FS8114J	78103553021	FP8114J	78103553121	8	1-1/4	100	Jar	48 Jars	0.63
FS8112J	78103553022	FP8112J	78103553122	8	1-1/2	100	Jar	48 Jars	0.67
FS8134J	78103553023	-		8	1-3/4	100	Jar	48 Jars	0.73
FS82J	78103553024	FP82J	78103553124	8	2	100	Jar	36 Jars	0.95
FS8212J	78103553025	FP8212J	78103553125	8	2-1/2	100	Jar	36 Jars	1.05
FS83J	78103553026	FP83J	78103553126	8	3	100	Jar	24 Jars	1.34
FS1034J	78103553028	FP1034J	78103553128	10	3/4	100	Jar	48 Jars	0.52
FS101J	78103553029	FP101J	78103553129	10	1	100	Jar	48 Jars	0.62
FS10114J	78103553030	FP10114J	78103553130	10	1-1/4	100	Jar	48 Jars	0.75
FS10112J	78103553031	FP10112J	78103553131	10	1-1/2	100	Jar	48 Jars	0.89
FS10134J	78103553032	-		10	1-3/4	100	Jar	48 Jars	1.03
FS102J	78103553033	FP102J	78103553133	10	2	100	Jar	36 Jars	1.24
FS10214J	78103553034	-		10	2-1/4	100	Jar	36 Jars	1.36
FS10212J	78103553035	FP10212J	78103553135	10	2-1/2	100	Jar	24 Jars	1.40
FS103J	78103553037	FP103J	78103553137	10	3	100	Jar	24 Jars	1.63
FS12114J	78103553041	FP12114J	78103553141	12	1-1/4	100	Jar	48 Jars	0.96
FS12112J	78103553042	FP12112J	78103553142	12	1-1/2	100	Jar	48 Jars	1.30
FS122J	78103553044	FP122J	78103553144	12	2	100	Jar	24 Jars	1.45
FS12212J	78103553045	FP12212J	78103553145	12	2-1/2	100	Jar	24 Jars	1.74
FS123J	78103553046	FP123J	78103553146	12	3	100	Jar	12 Jars	2.07
FS142J	78103553051	-		14	2	100	Jar	12 Jars	2.37
FS14212J	78103553052	-		14	2-1/2	100	Jar	12 Jars	2.68



[^] All Phillips head products are full thread.

* Jar version part number shown. Box and Bulk versions may be available. Contact Selecta for availability, part number and pricing.

[◇] Other quantities per individual package may be available. Contact Selecta for details.

Mechanical & Performance Requirements

Coarse Thread Drywall, Deck & Particle Board Screws

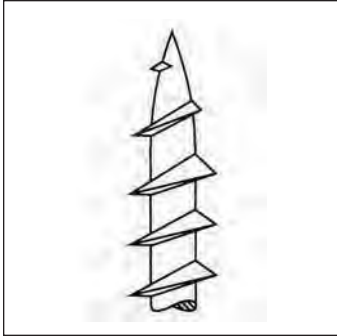

Description **Coarse Thread Drywall - Sharp point:** A bugle head screw with spaced threads, extra sharp point and black phosphate finish.

Particle Board Screw: Same as a coarse thread drywall screw but available in shorter lengths than standard drywall screws.

Deck Screw: A bugle head screw with spaced threads, extra sharp point and dactrotized finish.

Applications/ Advantages **Coarse Thread Drywall - Sharp point:** For attaching drywall to wood studs or to 25 gage metal studs.

Particle Board Screw: Designed specifically for use in dense woods, especially man-made types such as chipboard and particle board.

Deck Screw: Designed specifically for joining pieces of pressure treated lumber. Provides superior corrosion resistance without discoloring the wood.

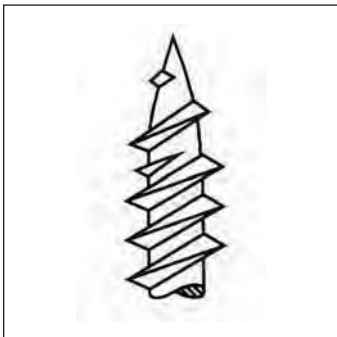

Fine Thread Drywall Screws

Description **Fine Thread Drywall - Sharp point:** A bugle head screw with twinfast thread, extra sharp point and black phosphate finish.

Fine Thread Drywall - Drill point: A bugle head screw with twin lead spaced thread, self drilling point and black phosphate finish.

Applications/ Advantages **Fine thread Drywall - Sharp point:** For attaching drywall to metal studs from 25 gauge through 20 gauge thick. Longer sizes are ideal for multiple layers or insulation.

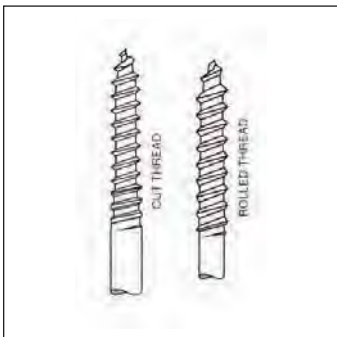

Wood Screws

Description A thread forming screw having a gimlet point, and a sharp crested, coarse pitch thread. Wood screws are produced two ways: Cut thread screws have a tapered shank; Rolled thread screws have a constant shank diameter.

Applications/ Advantages Will produce a mating thread when assembled into wood or other resilient materials.

Spring Wing Toggle Bolts Zinc-Plated Steel

CATALOG NUMBER*	UPC NUMBER	HEAD STYLE	DIAMETER & LENGTH	STD PAK [◇] PCS/PKG	PKG STYLE*	CASE QTY	WEIGHT/PKG (lbs.)
M183J	78103555004	Mushroom Combo	1/8 X 3	50	Jar	36 Jars	0.86
M184J	78103555005	Mushroom Combo	1/8 X 4	50	Jar	24 Jars	1.08
M3163J	78103555007	Mushroom Combo	3/16 X 3	50	Jar	24 Jars	1.72
M3164J	78103555008	Mushroom Combo	3/16 X 4	50	Jar	12 Jars	2.02
M143J	78103555011	Mushroom Combo	1/4 X 3	50	Jar	12 Jars	3.03
M144J	78103555012	Mushroom Combo	1/4 X 4	50	Jar	12 Jars	3.43
R182J	78103555060	Round Head Combo	1/8 X 2	50	Jar	48 Jars	0.74
R183J	78103555061	Round Head Combo	1/8 X 3	50	Jar	48 Jars	0.83
R184J	78103555062	Round Head Combo	1/8 X 4	50	Jar	24 Jars	0.94
R3162J	78103555063	Round Head Combo	3/16 X 2	50	Jar	24 Jars	1.39
R3163J	78103555064	Round Head Combo	3/16 X 3	50	Jar	24 Jars	1.68
R3164J	78103555065	Round Head Combo	3/16 X 4	50	Jar	24 Jars	1.93
* R3165J	78103555066	Round Head Combo	3/16 X 5	50	Jar	25 Jars	2.22
* R3166J	78103555067	Round Head Combo	3/16 X 6	50	Jar	12 Jars	2.60
R143J	78103555068	Round Head Combo	1/4 X 3	50	Jar	12 Jars	2.93
R144J	78103555069	Round Head Combo	1/4 X 4	50	Jar	12 Jars	3.37
* R145J	78103555070	Round Head Combo	1/4 X 5	50	Jar	12 Jars	3.93
* R146J	78103555071	Round Head Combo	1/4 X 6	50	Jar	12 Jars	4.43
* R5163J	78103555072	Round Head Combo	5/16 X 3	25	Jar	12 Jars	2.63
* R5164J	78103555073	Round Head Combo	5/16 X 4	25	Jar	12 Jars	3.02
* R5165J	78103555074	Round Head Combo	5/16 X 5	25	Jar	12 Jars	3.81
* R5166J	78103555075	Round Head Combo	5/16 X 6	25	Jar	12 Jars	3.79
R383J	78103555076	Round Head Combo	3/8 X 3	25	Jar	12 Jars	3.35
R384J	78103555077	Round Head Combo	3/8 X 4	25	Jar	12 Jars	4.35
* R385J	78103555078	Round Head Combo	3/8 X 5	25	Jar	12 Jars	4.82
* R386J	78103555079	Round Head Combo	3/8 X 6	25	Jar	12 Jars	5.67
* R124J	78103555080	Round Head Combo	1/2 X 4	10	Jar	12 Jars	3.95
* R125J	78103555081	Round Head Combo	1/2 X 5	10	Jar	12 Jars	4.25
* R126J	78103555082	Round Head Combo	1/2 X 6	10	Jar	12 Jars	4.85
F182J	78103555052	Flat Head Slotted	1/8 X 2	50	Jar	48 Jars	0.69
F183J	78103555053	Flat Head Slotted	1/8 X 3	50	Jar	36 Jars	0.87
F184J	78103555054	Flat Head Slotted	1/8 X 4	50	Jar	12 Jars	0.97
F3163J	78103555055	Flat Head Slotted	3/16 X 3	50	Jar	24 Jars	1.65
F3164J	78103555056	Flat Head Slotted	3/16 X 4	50	Jar	24 Jars	2.10
F143J	78103555050	Flat Head Slotted	1/4 X 3	50	Jar	12 Jars	2.88
F144J	78103555051	Flat Head Slotted	1/4 X 4	50	Jar	12 Jars	3.33



Spring Wing Toggle Heads Zinc-Plated Steel

CATALOG NUMBER*	UPC NUMBER	SIZE	STD PAK [◇] PCS/PKG	PKG STYLE*	CASE QTY	WEIGHT/PKG (lbs.)
TW18J	78103555090	1/8	100	Jar	48 Jars	0.74
TW316J	78103555091	3/16	100	Jar	12 Jars	1.64
TW14J	78103555092	1/4	100	Jar	12 Jars	2.18
TW516J	78103555093	5/16	100	Jar	12 Jars	4.20
TW38J	78103555094	3/8	25	Jar	12 Jars	1.515
TW12J	78103555095	1/2	25	Jar	12 Jars	4.42



* Sizes slotted only

+ Jar version part number shown. Box and Bulk versions may be available. Contact Selecta for availability, part number and pricing.

◇ Other quantities per individual package may be available. Contact Selecta for details.

Hollow Wall Anchors Zinc-Plated Steel



CATALOG NUMBER*	UPC NUMBER	SIZE	WALL THICKNESS	DRILL SIZE	STD PAK [◇] PCS/PKG	PKG STYLE*	CASE QTY	WEIGHT/PKG (lbs.)
HWA18XSJ	78103559203	1/8XS	UP TO 1/4"	5/16	100	Jar	48 Jars	0.96
HWA18SJ	78103559204	1/8S	1/8 - 1/2"	5/16	100	Jar	36 Jars	1.37
HWA18LJ	78103559205	1/8L	5/8 - 7/8	5/16	100	Jar	24 Jars	1.84
HWA18XLJ	78103559206	1/8XL	1-1/4 - 1-1/2	5/16	100	Jar	12 Jars	2.25
HWA316SJ	78103559207	3/16S	1/8 - 5/8	3/8	50	Jar	12 Jars	1.73
HWA316LJ	78103559208	3/16L	5/8 - 1-3/16	3/8	50	Jar	12 Jars	2.08
HWA316XLJ	78103559209	3/16XL	1-1/4 - 1-3/4	3/8	50	Jar	12 Jars	2.25
HWA14SJ	78103559210	1/4S	1/8 - 5/8	1/2	50	Jar	12 Jars	2.60
HWA14LJ	78103559211	1/4L	5/8 - 1-3/16	1/2	50	Jar	12 Jars	3.65
HWA14XLJ	78103559212	1/4XL	1-1/4 - 1-3/4	1/2	50	Jar	12 Jars	3.88

Hollow Wall Anchors • Drive Type



CATALOG NUMBER*	UPC NUMBER	SIZE	WALL THICKNESS	STD PAK [◇] PCS/PKG	PKG STYLE*	CASE QTY	WEIGHT/PKG (lbs.)
HWD18SJ	78103559220	1/8S	1/8-1/2	100	Jar	36 Jars	1.74
HWD18LJ	78103559221	1/8L	1/8-13/16	100	Jar	24 Jars	1.76

Hanger Bolts & Drivers • Zinc Chromate



CATALOG NUMBER*	UPC NUMBER	SIZE	STD PAK [◇] PCS/PKG	PKG STYLE*	CASE QTY	WEIGHT/PKG (lbs.)
HB143J	78103560603	1/4 X 3	100	Jar	24 Jars	3.04
HB144J	78103560604	1/4 X 4	100	Jar	24 Jars	4.04
HB383J	78103560607	3/8 X 3	50	Jar	12 Jars	3.83
HB384J	78103560608	3/8 X 4	50	Jar	24 Jars	4.71
HB386J	78103560610	3/8 X 6	50	Jar	12 Jars	7.31
HBD14	78103520621	1/4-20 X 2-9/16	1	Bag	N/A	0.06
HBD38	78103520625	3/8-16 X 2-9/16	1	Bag	N/A	0.08

Acoustical Lag Screws • Zinc Chromate



CATALOG NUMBER*	UPC NUMBER	SIZE	STD PAK [◇] PCS/PKG	PKG STYLE*	CASE QTY	WEIGHT/PKG (lbs.)
AL14J	78103560703	1/4 X 3	100	Jar	24 Jars	2.35
*ALDTSJ	78103560715	1/4 X 2	100	Jar	36 Jars	2.10



Acoustical Lag Screw Driver



CATALOG NUMBER*	UPC NUMBER	STD PAK [◇] PCS/PKG	PKG STYLE*	CASE QTY	WEIGHT/PKG (lbs.)
LSA	78103560720	1	Bag	N/A	0.13

* Self-drilling for steel.

+ Jar version part number shown. Box and Bulk versions may be available. Contact Selecta for availability, part number and pricing.

◇ Other quantities per individual package may be available. Contact Selecta for details.

Eye Bolts with Hex Nuts Steel, Zinc Chromate

CATALOG NUMBER*	UPC NUMBER	SIZE & THREAD LENGTH	I.D. OF EYE	STD PAK [◇] PCS/PKG	PKG STYLE*	CASE QTY	WEIGHT/PKG (lbs.)
EB102J	78103560500	10-24 X 2	5/16	100	Jar	36 Jars	2.19
EB142J	78103560503	1/4-20 X 2	9/16	100	Jar	12 Jars	4.20
EB14212J	78103560510	1/4-20 X 2-1/2	9/16	100	Jar	12 Jars	4.78
EB143J	78103560515	1/4-20 X 3	9/16	100	Jar	12 Jars	5.20
EB14312J	78103560516	1/4-20 X 3-1/2	9/16	100	Jar	25 Jars	5.75
EB144J	78103560517	1/4-20 X 4	9/16	100	Jar	12 Jars	6.41
EB382J	78103560533	3/8-16 X 2	1	50	Jar	12 Jars	6.77
EB384J	78103560537	3/8-16 X 4	1	25	Jar	12 Jars	4.36
EB385J	78103560539	3/8-16 X 5	1	25	Jar	12 Jars	4.97
EB386J	78103560541	3/8-16 X 6	1	25	Jar	12 Jars	5.55
EB126J	78103560551	1/2-13 X 6	1-1/4	10	Jar	12 Jars	4.49
EB128J	78103560553	1/2-13 X 8	1-1/4	10	Jar	12 Jars	5.50
EB1210	78103560557	1/2-13 X 10	1-1/4	10	Box	N/A	6.29
EB1212	78103560561	1/2-13 X 12	1-1/4	10	Box	N/A	7.13



Screw Eyes with Lag Screw Thread Steel, Zinc Chromate

CATALOG NUMBER*	UPC NUMBER	O.A.L./ WIRE DIAMETER	I.D. OF EYE	STD PAK [◇] PCS/PKG	PKG STYLE*	CASE QTY	WEIGHT/PKG (lbs.)
SE1516J	78103560310	1-5/16 X .135	1/4	100	Jar	48 Jars	1.50
SE11516J	78103560311	1-15/16 X .192	9/16	100	Jar	36 Jars	2.44
SE2316J	78103560312	2-3/16 X .225	5/8	100	Jar	12 Jars	4.01
SE258J	78103560313	2-5/8 X .262	3/4	100	Jar	12 Jars	7.14
SE514J	78103560318	5-1/4 X .438	1	20	Jar	12 Jars	6.71
SE8	78103520323	8 X .438	1	20	Box	N/A	9.40



Eye Couplings Steel, Zinc Chromate

CATALOG NUMBER*	UPC NUMBER	SIZE	LENGTH	STD PAK [◇] PCS/PKG	PKG STYLE*	CASE QTY	WEIGHT/PKG (lbs.)
EC1420J	78103560750	1/4-20	1-1/2	100	Jar	36 Jars	3.02



Screw Hooks with Lag Screw Thread Steel, Zinc Chromate

CATALOG NUMBER*	UPC NUMBER	SIZE	HOOK OPENING	STD PAK [◇] PCS/PKG	PKG STYLE*	CASE QTY	WEIGHT/PKG (lbs.)
SH2116J	78103560405	2-1/16 X .135	3/8	100	Jar	36 Jars	1.14
SH2916J	78103560407	2-9/16 X .162	9/16	100	Jar	24 Jars	2.10
SH338J	78103560409	3-3/8 X .192	3/4	100	Jar	12 Jars	3.86
SH418J	78103560410	4-7/16 X .262	1	50	Jar	12 Jars	5.05



* Jar version part number shown. Box and Bulk versions may be available. Contact Selecta for availability, part number and pricing.
[◇] Other quantities per individual package may be available. Contact Selecta for details.

Jack Chain Zinc-Plated Steel & Stainless Steel (SS)



CATALOG NUMBER	UPC NUMBER	SIZE	WORKING LOAD LIMIT	STD PAK [◇] FEET/PKG	PKG STYLE*	WEIGHT/PKG (lbs.)
JAC12	78103520203	#12	29#	50' Box	Box	4.46
JAC12C	78103520205	#12	29#	100' Spool	Spool	9.13
JAC12CB	78103520204	#12	29#	100' Box	Box	8.90
JAC12F	78103520206	#12	29#	500' Spool	Spool	45.65
JAC12SS	78103520208	#12	29#	100' Box	Box	8.92
JAC10	78103520207	#10	43#	50' Box	Box	7.26
JAC10CBSS	78103520209	#10	43#	100' Box	Box	15.00

Double Loop Chain Zinc-Plated Steel & Stainless Steel (SS)



CATALOG NUMBER	UPC NUMBER	SIZE	WORKING LOAD LIMIT	STD PAK [◇] FEET/PKG	PKG STYLE*	WEIGHT/KG (lbs.)
DLC3	78103520210	#3	90	100' Box	Box	6.05
DLC3R	78103520211	#3	90	500' Spool	Spool	34.45
DLC3SS	78103520212	#3	90	100' Box	Box	6.34

S-Hooks • Steel, Zinc Chromate



CATALOG NUMBER*	UPC NUMBER	SIZE	STD PAK [◇] PCS/PKG	PKG STYLE*	CASE QTY	WEIGHT/PKG (lbs.)
SK78J	78103560303	7/8 X .092	100	Jar	48 Jars	0.44
SK114J	78103560304	1-1/4 X .120	100	Jar	48 Jars	0.96
SK112J	78103560305	1-1/2 X .135	100	Jar	36 Jars	1.43

Fixture Hooks for Hanging Industrial Fluorescent Fixtures • Zinc-Plated Steel

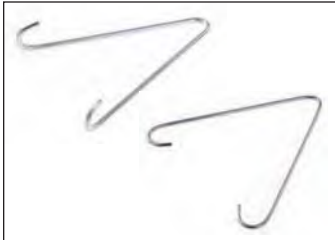

CATALOG NUMBER	UPC NUMBER	SIZE	STD PAK [◇] PCS/PKG	PKG STYLE*	CASE QTY	WEIGHT/PKG (lbs.)
FFH1	78103523403	End Mount	100	Box	12	4.66
FFH2	78103523404	Side Mount	100	Box	12	4.41

Perforated Strap Iron 10 Foot Coils



CATALOG NUMBER	UPC NUMBER	SIZE	STD PAK [◇] PCS/PKG	PKG STYLE*	CASE QTY	WEIGHT/PKG (lbs.)
PSI34	78103523060	20 Gauge X 3/4	10-10 FT. Coils	Box	N/A	7.80

Tie Wire 3 1/2 # Coils • 332 Ft.



CATALOG NUMBER	UPC NUMBER	DESCRIPTION	STD PAK [◇] PCS/PKG	PKG STYLE*	CASE QTY	WEIGHT/PKG (lbs.)
ATW16	78103523050	16 Gauge	1 Coil	Box	20	3.75
ATWG16	78103523051	16 Gauge Galvanized	1 Coil	Box	20	3.83

* Jar version part number shown. Box and Bulk versions may be available. Contact Selecta for availability, part number and pricing.
[◇] Other quantities per individual package may be available. Contact Selecta for details.

1/4" Hand Drive Pins Zinc-Plated Steel

CATALOG NUMBER*	UPC NUMBER	SIZE	STD PAK [◇] PCS/PKG	PKG STYLE*	CASE QTY	WEIGHT/PKG (lbs.)
DP34J	78103559103	3/4"	100	Jar	48 Jars	0.61
DP1J	78103559104	1"	100	Jar	48 Jars	0.63
DP114J	78103559105	1-1/4"	100	Jar	48 Jars	0.82
DP112J	78103559106	1-1/2"	100	Jar	48 Jars	0.94
DP2J	78103559107	2"	100	Jar	48 Jars	1.18
DP212J	78103559108	2-1/2"	100	Jar	36 Jars	1.55

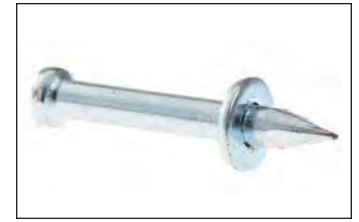

Hand Drive Tool

CATALOG NUMBER	UPC NUMBER	STD PAK [◇] PCS/PKG	CASE QTY	WEIGHT/PKG (lbs.)
HDT-10	78103519003	1	N/A	0.51

How to Make Fastenings in Masonry Without Drilling or Bolting:

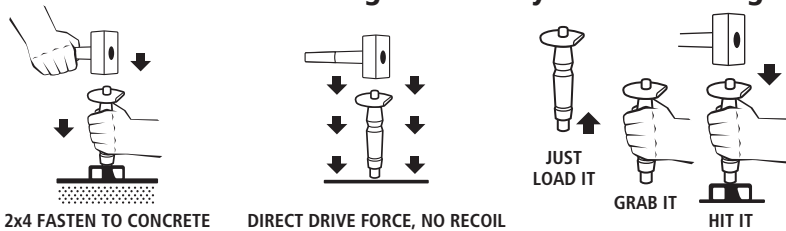

Easy to use!
For best results,
use a 3 lb. hammer



Threaded Rod[◊] • Zinc-Plated Steel

CATALOG NUMBER	UPC NUMBER	SIZE	BUNDLE QUANTITY	WEIGHT/PKG (lbs.)
TR14	78103520004	1/4-20 X 6'	50	43.00
TR516	78103520005	5/16-18 X 6'	40	46.00
TR38	78103520006	3/8-16 X 6'	25	40.00
TR12	78103520007	1/2-13 X 6'	12	38.00
TR34	78103520009	3/4-10 X 6'	5	40.00



Hex Rod Coupling^μ • Zinc-Plated Steel

CATALOG NUMBER*	UPC NUMBER	SIZE	STD PAK [◇] PCS/PKG	PKG STYLE*	CASE QTY	WEIGHT/PKG (lbs.)
RC14J	78103560024	1/4-20 X 7/8	100	Jar	48 Jars	1.97
RC516J	78103560025	5/16-18 X 1-1/8	100	Jar	36 Jars	3.12
RC38J	78103560026	3/8-16 X 1-1/8	100	Jar	12 Jars	3.75
RC38LJ	78103560032	3/8-16 X 1-3/4	50	Jar	N/A	5.71
RC12J	78103560027	1/2-13 X 1-1/4	50	Jar	24 Jars	2.80
RC12LJ	78103560033	1/2-13 X 1-3/4	50	Jar	25 Jars	5.90
RC58J	78103560028	5/8-11 X 2-1/8	50	Jar	12 Jars	4.33
RC34J	78103560029	3/4-10 X 2-1/4	50	Jar	6 Jars	14.38



Beam Clamp • Zinc-Plated Steel

CATALOG NUMBER	UPC NUMBER	SIZE	STD PAK [◇] PCS/PKG	PKG STYLE	CASE QTY	WEIGHT/PKG (lbs.)
UC1420	78103520103	1/4-20	100	Box	24	14.30
UC3816	78103520104	3/8-16	50	Box	12	14.30

Beam Clamp assembled with bolts, fits on beam flange up to 1/2"



[◊] Available in stainless steel; call for pricing.

^μ Longer lengths available; call for pricing.

* Jar version part number shown. Box and Bulk versions may be available. Contact Selecta for availability, part number and pricing.

[◇] Other quantities per individual package may be available. Contact Selecta for details.

Fixture Hanging Accessories Vertigo® Threaded Rod Anchoring System

Saves money and time when attaching threaded rod to wood and metal.

- No more predrilling metal or wood. Faster than beam clamps
- Easier to install than powder-actuated stud pin and coupling nut assemblies
- Replaces coach screws, hanger bolts, swing connectors and ceiling flanges
- Hang and support applications like fire sprinklers, lighting, and HVAC/R systems
- Anchors self-drill in metal up to .250"



Vertical Mount, Metal Drilling



Vertical Mount, Wood Drilling



Side Mount, Metal Drilling



Side Mount, Wood Drilling



HMDB-5/8 Recessed Drive Socket*

Metal Applications:

Tapped to accept 1/4-20 Threads
Tapped to accept 3/8-16 Threads

Wood Applications:

Tapped to accept 1/4-20 Threads
Tapped to accept 3/8-16 Threads

Recessed Drive Socket - It Backs Off:

Install tool for wood and metal Vertigo® anchors*

We do not recommend using regular socket drive products to install Vertigo®.

CATALOG NUMBER*	UPC NUMBER	SIZE/ DESCRIPTION	STD PAK [◇] PCS/PKG	PKG STYLE*	CASE QTY	WEIGHT/ PKG (lbs.)
VERTICAL MOUNT						
HMA1420J	78103560040	1/4-20 Vertical Mount Metal Drilling	50	Jar	24 Jars	3.70
HMA3816J	78103560041	3/8-16 Vertical Mount Metal Drilling	50	Jar	24 Jars	4.03
HMA1420WJ	78103560042	1/4-20 Vertical Mount Wood Drilling	50	Jar	12 Jars	4.13
HMA3816WJ	78103560043	3/8-16 Vertical Mount Wood Drilling	50	Jar	12 Jars	4.49
SIDE MOUNT						
HMA1420SMJ	78103580620	1/4-20 x 1" Side Mount Metal Drilling	50	Jar	24 Jars	3.65
HMA3816SMJ	78103580323	3/8-16 x 1" Side Mount Metal Drilling	50	Jar	24 Jars	3.98
HMA1420SMWJ	78103580621	1/4-20 x 1" Side Mount Wood Drilling	50	Jar	12 Jars	4.07
HMA3816SMWJ	78103580248	3/8-16 x 2" Side Mount Wood Drilling	50	Jar	12 Jars	4.41
RECESSED DRIVE SOCKET						
HMDB-5/8	78103520046	Recessed Drive Socket*	1	Bag	N/A	0.11

* The HMDB-5/8 Recessed Drive Socket can be used on all products shown in the table above: Vertical Mount, Metal Drilling & Wood Drilling, and Side Mount, Metal Drilling & Wood Drilling.

Installation Instruction (Metal & Wood)

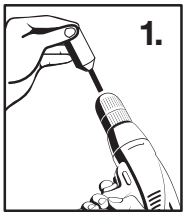

1.

Insert Vertigo® recessed drive socket into screw gun.

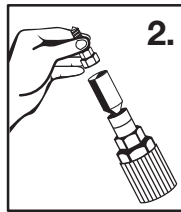

2.

Insert appropriate Vertigo® anchor into drive socket.

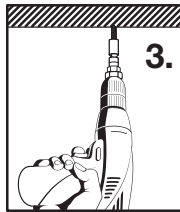

3.

Position the self-drilling point of the anchor at the intended point of installation. The drive socket's SafetySet feature will set the anchor flush and then automatically disengage to prevent overdrilling.

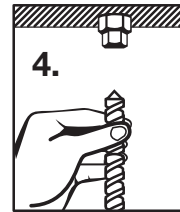

4.

The Vertigo® anchor is now installed and ready to accept a threaded rod or component.

Product Performance & Technical Data

Pullout Testing in Steel

	(1/8)	(3/16)	(1/4)
Steel Thickness	.109"	.123"	.155"
Avg. Pullout in lbs.	2068	2180	3188

Pullout Testing in Wood

	1 3/4"	2 1/4"
Specific Gravity	.4302	.4730
Embedment Depth	1 3/4"	2 1/4"
Avg. Pullout in lbs.	1384	2090

IMPORTANT:

Contact Selecta for Vertigo® Concrete Applications.

◇ Jar version part number shown. Box and Bulk versions may be available. Contact Selecta for availability, part number and pricing.

◇ Other quantities per individual package may be available. Contact Selecta for details.

* The HMDB-5/8 Recessed Drive Socket can be used on all products shown in the table above: Vertical Mount, Metal Drilling & Wood Drilling, and Side Mount, Metal Drilling & Wood Drilling.

Cable Ties • Nylon Packed 100 Per Poly Bag

CATALOG NUMBER	MIN UPC NUMBER	MAX TENSILE STRENGTH	BUNDLE DIAMETER	OVERALL LENGTH	MILITARY SPECS	STD PAK [◇] PCS/PKG	PKG STYLE	CASE QTY	WEIGHT/PKG (lbs.)
TIE4	78103521003	18 Lbs.	7/8"	4"	MS3367-4	100	Bag	24	0.07
TIE4M	78103521020	18 Lbs.	7/8"	4"	MS3367-4	1000	Bag	12	0.62
TIE5	78103521004	40 Lbs.	1-1/4"	5"	N/A	100	Bag	12	0.17
TIE5M	78103521018	40 Lbs.	1-1/4"	5"	N/A	1000	Bag	12	0.75
TIE6	78103521005	40 Lbs.	1-1/4"	5.8"	MS3367-5	100	Bag	12	0.20
TIE6M	78103521021	40 Lbs.	1-1/4"	5.8"	MS3367-5	1000	Bag	12	1.53
TIE8	78103521006	50 Lbs.	1-3/4"	7.6"	MS3367-1	100	Bag	12	0.25
TIE8M	78103521023	50 Lbs.	1-3/4"	7.6"	MS3367-1	1000	Bag	12	2.65
TIE11	78103521007	50 Lbs.	3"	11.1"	MS3367-7	100	Bag	12	0.38
TIE11M	78103521028	50 Lbs.	3"	11.1"	MS3367-7	1000	Bag	12	1.97
TIE15	78103521008	50 Lbs.	4"	14.6"	MS3367-2	100	Bag	12	0.47
TIE15M	78103521029	50 Lbs.	4"	14.6"	MS3367-2	500	Bag	12	2.59



Heavy Duty Adjustable Clamps Straight Tip

CATALOG NUMBER	MIN UPC NUMBER	MAX TENSILE STRENGTH	BUNDLE DIAMETER	OVERALL LENGTH	MILITARY SPECS	STD PAK [◇] PCS/PKG	PKG STYLE	CASE QTY	WEIGHT/PKG (lbs.)
TIE15EHD	78103521014	175 Lbs.	4"	17"	N/A	100	Bag	12	1.80
TIE16LHDB	78103521015	120 Lbs.	4"	17"	MS3369-3	100	Bag	12	1.18
TIE21EHD	78103521016	175 Lbs.	6"	24"	N/A	50	Bag	12	1.35
TIE30EHDB	78103521017	175 Lbs.	8-1/2"	36"	MS3367-6	50	Bag	12	1.98



Black Weather Resistant Bent Tip

CATALOG NUMBER	MIN UPC NUMBER	MAX TENSILE STRENGTH	BUNDLE DIAMETER	OVERALL LENGTH	MILITARY SPECS	STD PAK [◇] PCS/PKG	PKG STYLE	CASE QTY	WEIGHT/PKG (lbs.)
TIE4B	78103521026	18 Lbs.	3/4"	4"	MS3367-4-0	100	Bag	24	0.07
TIE4BM	78103521060	18 Lbs.	3/4"	4"	MS3367-4-0	1000	Bag	12	0.62
TIE6B	78103521019	40 Lbs.	1-1/4"	5.8"	MS3367-5-0	100	Bag	12	0.17
TIE6BM	78103521062	40 Lbs.	1-1/4"	5.8"	MS3367-5-0	1000	Bag	12	2.76
TIE8B	78103521022	50 Lbs.	1-3/4"	7.6"	MS3367-1-0	100	Bag	12	0.28
TIE8BM	78103521063	50 Lbs.	1-3/4"	7.6"	MS3367-1-0	1000	Bag	12	3.00
TIE11B	78103521027	50 Lbs.	4"	11.1"	MS3367-7-0	100	Bag	12	0.38
TIE11BM	78103521064	50 Lbs.	4"	11.1"	MS3367-7-0	1000	Bag	12	2.02
TIE15B	78103521024	50 Lbs.	4"	14.6"	MS3367-2-0	100	Bag	12	0.50
TIE15BM	78103521065	50 Lbs.	4"	14.6"	MS3367-2-0	1000	Bag	12	5.18



Nylon Mounting Tab Cable Tie Bent Tip

CATALOG NUMBER	MIN UPC NUMBER	MAX TENSILE STRENGTH	BUNDLE DIAMETER	OVERALL LENGTH	MOUNTING SCREW SIZE	STD PAK [◇] PCS/PKG	PKG STYLE	CASE QTY	WEIGHT/PKG (lbs.)
TIE4TB	78103521009	18 Lbs.	3/4"	4"	#4	100	Bag	12	0.11
TIE6TB	78103521010	40 Lbs.	1-1/4"	6"	#8	100	Bag	12	0.19
TIE8TB	78103521011	50 Lbs.	1-3/4"	8.6"	#10	100	Bag	12	0.36
TIE11TB	78103521060	50 Lbs.	4"	11"	#10	100	Bag	12	0.53
TIE15TB	78103521012	50 Lbs.	4"	14.5"	#10	100	Bag	12	0.63
TIE16TB	78103521013	120 Lbs.	4"	15"	1/4"	100	Bag	12	1.33



[◇] Other quantities per individual package may be available. Contact Selecta for details.

Nylon Cable Clamps Natural or UV Black[^]



CATALOG NUMBER [*]	UPC NUMBER	CABLE DIAMETER	STD PAK [◇] PCS/PKG	PKG STYLE [*]	CASE QTY	WEIGHT/PKG (lbs.)
CC18J	78103561030	1/8"	100/Jar	Jar	48 Jars	0.14
[^] CC18BJ	78103561040	1/8"	100/Jar	Jar	48 Jars	0.14
CC14J	78103561031	1/4"	100/Jar	Jar	48 Jars	0.19
[^] CC14BJ	78103561041	1/4"	100/Jar	Jar	48 Jars	0.19
CC38J	78103561032	3/8"	100/Jar	Jar	36 Jars	0.25
[^] CC38BJ	78103561042	3/8"	100/Jar	Jar	24 Jars	0.24
CC12J	78103561033	1/2"	100/Jar	Jar	36 Jars	0.29
[^] CC12BJ	78103561043	1/2"	100/Jar	Jar	24 Jars	0.26

Adhesive or Screw-In Mounting Tabs Natural or UV Black[^]



CATALOG NUMBER	UPC NUMBER	CABLE DIAMETER	STD PAK [◇] PCS/PKG	PKG STYLE	CASE QTY	WEIGHT/PKG (lbs.)
MB3A	78103521051	3/4" Sq	100/Box	Box	12	0.22
[^] MB3AB	78103521052	3/4" Sq	100/Box	Box	12	0.21
MB4A	78103521050	1-1/8" Sq	100/Box	Box	24	0.37
[^] MB4AB	78103521053	1-1/8" Sq	100/Box	Box	12	0.38



Heavy Duty Cable Tie Installation Tool Simple and easy to use. Accommodates Cable Tie Series TIE4-TIE15TB

CATALOG NUMBER	UPC NUMBER	SIZE	STD PAK [◇] PCS/PKG	PKG STYLE	WEIGHT/PKG (lbs.)
CTT-1	78103521025	T18R-T50ML	1/Bag	Bag	0.56



Nail-In Plastic Cable Clips (White) Hardened Steel[§]



CATALOG NUMBER [*]	UPC NUMBER	SIZE	CLIP TOL INCHES	MM	NAIL LENGTH	APPLICATION	STD PAK [◇] PCS/PKG	PKG STYLE	CASE QTY	WEIGHT/PKG (lbs.)
CCNI532J	78103561070	5/32	.16	4.00	3/4	Groundwire	100	Jar	48 Jars	0.20
			.19	4.75						
CCNI316J	78103561072	3/16	.19	4.75	3/4	Groundwire	100	Jar	48 Jars	0.21
			.23	5.75						
CCNI14J	78103561074	1/4	.23	5.75	1	RG59/V Coaxial Cable	100	Jar	48 Jars	0.28
			.27	6.75						
CCNI516J	78103561076	5/16	.27	6.75	1	Drop Line RG6/U Coaxial	100	Jar	48 Jars	0.32
CCNI38J	78103561078	3/8	.32	8.00	1	RG9, RG6, QUAD RG11 QUAD	100	Jar	48 Jars	0.50
			.32	8.00						
CCNI12J	78103561080	1/2	.40	10.00	1-3/16	RG11/U Coaxial	100	Jar	24 Jars	0.60
			.40	10.00						

[^] UV Black.

^{*} Jar version part number shown. Box and Bulk versions may be available. Contact Selecta for availability, part number and pricing.

[◇] Other quantities per individual package may be available. Contact Selecta for details.

[§] Suitable for wood, masonry joints or cement block.

Hexagon Bolts • Steel, Zinc Chromate^Δ

HCS Grade 2, Full Thread • HCS/G5 Grade 5, Full Thread

CATALOG NO. HCS*	UPC NUMBER	CATALOG NO. HCS/G5*	UPC NUMBER	DIAMETER	LENGTH	STD PAK [◇] PCS/PKG	PKG STYLE*	CASE QTY	WEIGHT/ PKG (lbs.)
HCS1412J	78103568001	HCS1412G5J	78103568201	1/4-20	1/2	100	Jar	48 Jars	1.24
HCS1458J	78103568002	HCS1458G5J	78103568202	1/4-20	5/8	100	Jar	48 Jars	1.32
HCS1434J	78103568003	HCS1434G5J	78103568203	1/4-20	3/4	100	Jar	48 Jars	1.47
HCS141J	78103568004	HCS141G5J	78103568204	1/4-20	1	100	Jar	48 Jars	1.72
HCS14114J	78103568005	HCS14114G5J	78103568205	1/4-20	1-1/4	100	Jar	36 Jars	2.11
HCS14112J	78103568006	HCS14112G5J	78103568206	1/4-20	1-1/2	100	Jar	36 Jars	2.47
HCS142J	78103568008	HCS142G5J	78103568208	1/4-20	2	100	Jar	24 Jars	3.15
HCS14214J	78103568009	HCS14214G5J	78103568209	1/4-20	2-1/4	100	Jar	24 Jars	3.51
HCS14212J	78103568010	HCS14212G5J	78103568210	1/4-20	2-1/2	100	Jar	12 Jars	3.86
HCS14234J	78103568011	HCS14234G5J	78103568211	1/4-20	2-3/4	100	Jar	12 Jars	4.16
HCS143J	78103568012	HCS143G5J	78103568212	1/4-20	3	100	Jar	12 Jars	4.45
HCS14312J	78103568013	HCS14312G5J	78103568213	1/4-20	3-1/2	100	Jar	12 Jars	4.68
HCS144J	78103568014	HCS144G5J	78103568214	1/4-20	4	100	Jar	12 Jars	5.95
HCS51634J	78103568019	HCS51634G5J	78103568219	5/16-18	3/4	100	Jar	48 Jars	2.48
HCS5161J	78103568020	HCS5161G5J	78103568220	5/16-18	1	100	Jar	36 Jars	2.83
HCS516114J	78103568021	HCS516114G5J	78103568221	5/16-18	1-1/4	100	Jar	36 Jars	3.31
HCS516112J	78103568022	HCS516112G5J	78103568222	5/16-18	1-1/2	100	Jar	24 Jars	3.91
HCS516134J	78103568023	HCS516134G5J	78103568223	5/16-18	1-3/4	100	Jar	24 Jars	4.45
HCS5162J	78103568024	HCS5162G5J	78103568224	5/16-18	2	100	Jar	12 Jars	4.98
HCS516212J	78103568026	HCS516212G5J	78103568226	5/16-18	2-1/2	100	Jar	12 Jars	6.09
HCS5163J	78103568028	HCS5163G5J	78103568228	5/16-18	3	100	Jar	12 Jars	7.11
HCS5164J	78103568030	HCS5164G5J	78103568230	5/16-18	4	100	Jar	12 Jars	9.24
HCS3812J	78103568034	HCS3812G5J	78103568234	3/8-16	1/2	100	Jar	36 Jars	2.86
HCS3834J	78103568035	HCS3834G5J	78103568235	3/8-16	3/4	100	Jar	24 Jars	3.80
HCS381J	78103568036	HCS381G5J	78103568236	3/8-16	1	100	Jar	24 Jars	4.20
HCS38114J	78103568037	HCS38114G5J	78103568237	3/8-16	1-1/4	100	Jar	12 Jars	4.75
HCS38112J	78103568038	HCS38112G5J	78103568238	3/8-16	1-1/2	100	Jar	12 Jars	5.60
HCS38134J	78103568039	HCS38134G5J	78103568239	3/8-16	1-3/4	100	Jar	12 Jars	6.47
HCS382J	78103568040	HCS382G5J	78103568240	3/8-16	2	100	Jar	12 Jars	7.31
HCS38212J	78103568042	HCS38212G5J	78103568242	3/8-16	2-1/2	50	Jar	12 Jars	4.39
HCS38234J	78103568043	HCS38234G5J	78103568243	3/8-16	2-3/4	50	Jar	12 Jars	4.79
HCS383J	78103568044	HCS383G5J	78103568244	3/8-16	3	50	Jar	12 Jars	5.19
HCS38312J	78103568045	HCS38312G5J	78103568245	3/8-16	3-1/2	50	Jar	12 Jars	6.02
HCS384J	78103568046	HCS384G5J	78103568246	3/8-16	4	50	Jar	12 Jars	6.75
HCS1234J	78103568050	HCS1234G5J	78103568250	1/2-13	3/4	50	Jar	24 Jars	3.80
HCS121J	78103568051	HCS121G5J	78103568251	1/2-13	1	50	Jar	12 Jars	4.25
HCS12114J	78103568052	HCS12114G5J	78103568252	1/2-13	1-1/4	50	Jar	12 Jars	4.82
HCS12112J	78103568053	HCS12112G5J	78103568253	1/2-13	1-1/2	50	Jar	12 Jars	5.35
HCS12134J	78103568054	HCS12134G5J	78103568254	1/2-13	1-3/4	50	Jar	12 Jars	5.85
HCS122J	78103568055	HCS122G5J	78103568255	1/2-13	2	50	Jar	12 Jars	6.85
HCS12212J	78103568057	HCS12212G5J	78103568257	1/2-13	2-1/2	50	Jar	12 Jars	8.23
HCS123J	78103568059	HCS123G5J	78103568259	1/2-13	3	50	Jar	12 Jars	9.50
HCS12312J	78103568060	HCS12312G5J	78103568260	1/2-13	3-1/2	25	Jar	12 Jars	5.57
HCS124J	78103568061	HCS124G5J	78103568261	1/2-13	4	25	Jar	12 Jars	6.25



^Δ Other sizes available upon request. Stainless steel and silicon bronze on page H-2

* Jar version part number shown. Box and Bulk versions may be available. Contact Selecta for availability, part number and pricing.

[◇] Other quantities per individual package may be available. Contact Selecta for details.

Popular Sizes Hexagon Bolts^Δ 18-8 Stainless Steel



CATALOG NUMBER*	UPC NUMBER	DIAMETER	LENGTH	STD PAK [◇] PCS/PKG	PKG STYLE†	CASE QTY	WEIGHT/PKG (lbs.)
SHCS1412J	78103558501	1/4-20	1/2	100	Jar	48 Jars	1.24
SHCS1434J	78103558503	1/4-20	3/4	100	Jar	48 Jars	1.51
SHCS141J	78103558504	1/4-20	1	100	Jar	48 Jars	1.79
SHCS14114J	78103558505	1/4-20	1-1/4	100	Jar	36 Jars	2.12
SHCS14112J	78103558506	1/4-20	1-1/2	100	Jar	48 Jars	2.34
SHCS142J	78103558508	1/4-20	2	100	Jar	24 Jars	2.82
SHCS3812J	78103558534	3/8-16	1/2	100	Jar	36 Jars	2.89
SHCS3834J	78103558535	3/8-16	3/4	100	Jar	36 Jars	3.57
SHCS381J	78103558536	3/8-16	1	100	Jar	24 Jars	4.25
SHCS38114J	78103558537	3/8-16	1-1/4	100	Jar	24 Jars	4.92
SHCS38112J	78103558538	3/8-16	1-1/2	100	Jar	12 Jars	5.65
SHCS382J	78103558540	3/8-16	2	100	Jar	12 Jars	7.12
SHCS1234J	78103558550	1/2-13	3/4	50	Jar	12 Jars	3.59
SHCS121J	78103558551	1/2-13	1	50	Jar	24 Jars	4.27
SHCS12114J	78103558552	1/2-13	1-1/4	50	Jar	24 Jars	4.80
SHCS12112J	78103558553	1/2-13	1-1/2	50	Jar	12 Jars	5.46
SHCS122J	78103558555	1/2-13	2	50	Jar	12 Jars	6.63
SHCS12212J	78103558557	1/2-13	2-1/2	50	Jar	12 Jars	7.70

Popular Sizes Hexagon Bolts^Δ Silicon Bronze



CATALOG NUMBER*	UPC NUMBER	DIAMETER	LENGTH	STD PAK [◇] PCS/PKG	PKG STYLE†	CASE QTY	WEIGHT/PKG (lbs.)
SBHCS1412J	78103558601	1/4-20	1/2	100	Jar	48 Jars	1.39
SBHCS1434J	78103558603	1/4-20	3/4	100	Jar	48 Jars	1.64
SBHCS141J	78103558604	1/4-20	1	100	Jar	48 Jars	1.93
SBHCS14114J	78103558605	1/4-20	1-1/4	100	Jar	36 Jars	2.14
SBHCS14112J	78103558606	1/4-20	1-1/2	100	Jar	36 Jars	2.52
SBHCS5161J	78103558620	5/16-18	1	100	Jar	36 Jars	3.08
SBHCS3834J	78103558635	3/8-16	3/4	100	Jar	36 Jars	3.90
SBHCS381J	78103558636	3/8-16	1	100	Jar	24 Jars	4.65
SBHCS38114J	78103558637	3/8-16	1-1/4	100	Jar	24 Jars	5.25
SBHCS38112J	78103558638	3/8-16	1-1/2	100	Jar	12 Jars	6.20
SBHCS382J	78103558640	3/8-16	2	100	Jar	12 Jars	7.36
SBHCS121J	78103558651	1/2-13	1	50	Jar	24 Jars	4.66
SBHCS12114J	78103558652	1/2-13	1-1/4	50	Jar	12 Jars	5.33
SBHCS12112J	78103558653	1/2-13	1-1/2	50	Jar	12 Jars	5.93
SBHCS122J	78103558654	1/2-13	2	50	Jar	12 Jars	7.10
SBHCS12212J	78103558657	1/2-13	2-1/2	50	Jar	12 Jars	8.38
SBHCS123J	78103558659	1/2-13	3	50	Jar	12 Jars	9.49

^ΔOther sizes available upon request.

† Jar version part number shown. Box and Bulk versions may be available. Contact Selecta for availability, part number and pricing.

[◇] Other quantities per individual package may be available. Contact Selecta for details.

Hex Head Lag Bolts Steel, Zinc Chromate

CATALOG NUMBER*	UPC NUMBER	DIAMETER	LENGTH	STD PAK [◇] PCS/PKG	PKG STYLE†	CASE QTY	WEIGHT/PKG (lbs.)
LB141J	78103559301	1/4	1	100	Jar	48 Jars	1.54
LB14114J	78103559302	1/4	1-1/4	100	Jar	48 Jars	1.76
LB14112J	78103559303	1/4	1-1/2	100	Jar	36 Jars	1.97
LB14134J	78103559304	1/4	1-3/4	100	Jar	36 Jars	2.28
LB142J	78103559305	1/4	2	100	Jar	24 Jars	2.46
LB14212J	78103559306	1/4	2-1/2	100	Jar	12 Jars	3.15
LB143J	78103559307	1/4	3	100	Jar	12 Jars	3.64
LB14312J	78103559308	1/4	3-1/2	100	Jar	12 Jars	3.97
LB144J	78103559309	1/4	4	100	Jar	12 Jars	4.76
LB14412J	78103559310	1/4	4-1/2	100	Jar	12 Jars	5.25
LB145J	78103559311	1/4	5	100	Jar	12 Jars	5.606
LB146J	78103559312	1/4	6	100	Jar	12 Jars	6.51
LB5161J	78103559313	5/16	1	100	Jar	36 Jars	2.47
LB516114J	78103559314	5/16	1-1/4	100	Jar	36 Jars	2.55
LB516112J	78103559315	5/16	1-1/2	100	Jar	24 Jars	3.20
LB516134J	78103559316	5/16	1-3/4	100	Jar	12 Jars	3.37
LB5162J	78103559317	5/16	2	100	Jar	12 Jars	3.79
LB516212J	78103559318	5/16	2-1/2	100	Jar	12 Jars	4.84
LB5163J	78103559319	5/16	3	100	Jar	12 Jars	5.61
LB516312J	78103559320	5/16	3-1/2	50	Jar	12 Jars	3.19
LB5164J	78103559321	5/16	4	50	Jar	12 Jars	3.42
LB516412J	78103559322	5/16	4-1/2	50	Jar	12 Jars	4.01
LB5165J	78103559323	5/16	5	50	Jar	12 Jars	4.82
LB5166J	78103559324	5/16	6	50	Jar	12 Jars	5.61
LB381J	78103559325	3/8	1	50	Jar	48 Jars	1.69
LB38114J	78103559326	3/8	1-1/4	50	Jar	36 Jars	1.93
LB38112J	78103559327	3/8	1-1/2	50	Jar	36 Jars	2.32
LB38134J	78103559328	3/8	1-3/4	50	Jar	24 Jars	2.35
LB382J	78103559329	3/8	2	50	Jar	24 Jars	2.80
LB38212J	78103559330	3/8	2-1/2	50	Jar	12 Jars	3.48
LB383J	78103559331	3/8	3	50	Jar	12 Jars	3.97
LB38312J	78103559332	3/8	3-1/2	50	Jar	12 Jars	4.51
LB384J	78103559333	3/8	4	50	Jar	12 Jars	5.11
LB38412J	78103559334	3/8	4-1/2	50	Jar	12 Jars	5.64
LB385J	78103559335	3/8	5	50	Jar	12 Jars	6.18
LB38512J	78103559336	3/8	5-1/2	50	Jar	12 Jars	6.57
LB386J	78103559337	3/8	6	50	Jar	12 Jars	7.48
LB122J	78103559338	1/2	2	50	Jar	12 Jars	5.46
LB12212J	78103559339	1/2	2-1/2	50	Jar	12 Jars	6.51
LB123J	78103559340	1/2	3	50	Jar	12 Jars	7.58
LB12312J	78103559341	1/2	3-1/2	25	Jar	12 Jars	4.36
LB124J	78103559342	1/2	4	25	Jar	12 Jars	4.77
LB12412J	78103559343	1/2	4-1/2	25	Jar	12 Jars	5.32
LB125J	78103559344	1/2	5	25	Jar	12 Jars	5.99
LB12512J	78103559345	1/2	5-1/2	25	Jar	12 Jars	6.42
LB126J	78103559346	1/2	6	25	Jar	12 Jars	7.32



* Jar version part number shown. Box and Bulk versions may be available. Contact Selecta for availability, part number and pricing.
[◇] Other quantities per individual package may be available. Contact Selecta for details.

Lag Screw Shields Zinc Die Cast



CATALOG NUMBER*	UPC NUMBER	DIAMETER	LENGTH	STD PAK [◇] PCS/PKG	PKG STYLE*	CASE QTY	WEIGHT/ PKG (lbs.)
SHORT							
LSS141J	78103559401	1/4	1	50	Jar	48 Jars	1.35
LSS516114J	78103559402	5/16	1-1/4	50	Jar	36 Jars	1.65
LSS38134J	78103559403	3/8	1-3/4	50	Jar	12 Jars	2.21
LSS122J	78103559404	1/2	2	25	Jar	24 Jars	2.03
LONG							
LSL14112J	78103559407	1/4	1-1/2	50	Jar	36 Jars	1.73
LSL516134J	78103559408	5/16	1-3/4	50	Jar	24 Jars	1.98
LSL38212J	78103559409	3/8	2-1/2	50	Jar	12 Jars	3.73
LSL123J	78103559410	1/2	3	25	Jar	12 Jars	2.52

Carriage Bolts with Hex Nuts



CATALOG NUMBER*	UPC NUMBER	DIAMETER	LENGTH	STD PAK [◇] PCS/PKG	PKG STYLE*	CASE QTY	WEIGHT/ PKG (lbs.)
CB1412J	78103568101	1/4-20	1/2	100	Jar	48 Jars	1.32
CB1434J	78103568103	1/4-20	3/4	100	Jar	48 Jars	1.60
CB141J	78103568104	1/4-20	1	100	Jar	48 Jars	1.85
CB14112J	78103568106	1/4-20	1-1/2	100	Jar	36 Jars	2.41
CB142J	78103568108	1/4-20	2	100	Jar	24 Jars	2.98
CB143J	78103568112	1/4-20	3	100	Jar	12 Jars	4.65
CB3834J	78103568135	3/8-16	3/4	100	Jar	24 Jars	4.25
CB381J	78103568136	3/8-16	1	100	Jar	12 Jars	5.00
CB38112J	78103568138	3/8-16	1-1/2	100	Jar	12 Jars	6.00
CB382J	78103568140	3/8-16	2	100	Jar	12 Jars	7.40
CB38212J	78103568142	3/8-16	2-1/2	50	Jar	12 Jars	4.30
CB383J	78103568144	3/8-16	3	50	Jar	12 Jars	4.80
CB384J	78103568146	3/8-16	4	50	Jar	12 Jars	6.80
CB122J	78103568155	1/2-13	2	50	Jar	24 Jars	3.49
CB12212J	78103568157	1/2-13	2-1/2	50	Jar	12 Jars	4.05
CB123J	78103568159	1/2-13	3	50	Jar	12 Jars	4.58

+ Jar version part number shown. Box and Bulk versions may be available. Contact Selecta for availability, part number and pricing.
[◇] Other quantities per individual package may be available. Contact Selecta for details.

Wall Anchors & Kits Boxes or Jars

CATALOG NUMBER*	UPC NUMBER	SCREW SIZE	HOLE SIZE	STD PAK [◇] PCS/PKG	PKG STYLE*	CASE QTY	WEIGHT/PKG (lbs.)
PLASTIC CONICAL ANCHOR							
WA316J	78103559510	6-8	3/16	100	Jar	48 Jars	0.13
WA14J	78103559511	10-12	1/4	100	Jar	48 Jars	0.18
WA516J	78103559512	14-16	5/16	100	Jar	36 Jars	0.31



CATALOG NUMBER*	UPC NUMBER	SIZE	CONTENTS	PKG STYLE*	CASE QTY	WEIGHT/PKG (lbs.)
PLASTIC CONICAL ANCHOR WITH PAN HD COMBO TAPPING SCREWS						
PAK316	78103519503/box	3/16 Light Duty	100 3/16 Plastic Anchors 100 #6 X 1 Pan Cmb HD Screw Zinc 1 3/16 X 4 Masonry Drill	Box	50 Boxes	0.54
PAK316J	78103559503/jar		Same as above but in a jar	Jar	48 Jars	0.45
PAK14	78103519504/box	1/4 Medium Duty	100 1/4 Plastic Anchors 100 #10 X 1 Pan Cmb HD Screw Zinc 1 1/4 X 4 Masonry Drill	Box	50 Boxes	0.95
PAK14J	78103559504/jar		Same as above but in a jar	Jar	36 Jars	0.90
PAK14L	78103519506/box	1/4 Medium Duty	100 1/4 Plastic Anchors 100 #10 X 1-1/4 Pan Cmb HD Screw Zinc 1 1/4 X 4 Masonry Drill	Box	50 Boxes	1.08
PAK14LJ	78103559506/jar		Same as above but in a jar	Jar	36 Jars	0.96
PAK516	78103519505/box	5/16 Heavy Duty	50 5/16 Plastic Anchors 50 #12 X 1-1/4 Pan Cmb HD Screw Zinc 1 5/16 X 4 Masonry Drill	Box	50 Boxes	0.84
PAK516J	78103559505/jar		Same as above but in a jar	Jar	36 Jars	0.79



CATALOG NUMBER*	UPC NUMBER	SIZE	CONTENTS	PKG STYLE*	CASE QTY	WEIGHT/PKG (lbs.)
PLASTIC CONICAL ANCHOR WITH HEX WASHER HD TAPPING SCREWS						
HPAK316	78103519507/box	3/16 Light Duty	100 3/16 Plastic Anchors 100 #6 X 1 Hex Wsh HD Slot Screw Zinc 1 3/16 X 4 Masonry Drill	Box	50 Boxes	0.59
HPAK316J	78103559507/jar		Same as above but in a jar	Jar	48 Jars	0.52
HPAK14	78103519509/box	1/4 Medium Duty	100 1/4 Plastic Anchors 100 #10 X 1 Hex Wsh HD Slot Screw Zinc 1 1/4 X 4 Masonry Drill	Box	50 Boxes	0.97
HPAK14J	78103559509/jar		Same as above but in a jar	Jar	36 Jars	0.93
HPAK516	78103519508/box	5/16 Heavy Duty	50 5/16 Plastic Anchors 50 #12 X 1-1/4 Hex Wsh HD Slot Screw 1 5/16 X 4 Masonry Drill	Box	50 Boxes	0.84
HPAK516J	78103559508/jar		Same as above but in a jar	Jar	36 Jars	0.79

CATALOG NUMBER*	UPC NUMBER	SCREW SIZE	HOLE SIZE	STD PAK [◇] PCS/PKG	PKG STYLE*	CASE QTY	WEIGHT/PKG (lbs.)
SUPER YELLOW WINGED PLASTIC ANCHOR							
MX316J	78103559520	6-8	3/16	100	Jar	48 Jars	0.16
MX14J	78103559521	10-12	1/4	100	Jar	48 Jars	0.22
MX516J	78103559522	14-16	5/16	100	Jar	36 Jars	0.29



CATALOG NUMBER*	UPC NUMBER	SIZE	CONTENTS	PKG STYLE*	CASE QTY	WEIGHT/PKG (lbs.)
MX WINGED ANCHOR WITH PAN HD COMBO TAPPING SCREWS						
MXK316	78103519525/box	3/16 Light Duty	100 3/16 Plastic Anchors 100 #6 X 1" Pan Cmb HD Screw Zinc 1 3/16 X 4 Masonry Drill	Box	50 Boxes	0.56
MXK316J	78103559525/jar		Same as above but in a jar	Jar	48 Jars	0.51
MXK14	78103519526/box	1/4 Medium Duty	100 1/4 Plastic Anchors 100 #10 X 1 Pan Cmb HD Screw Zinc 1 1/4 X 4 Masonry Drill	Box	50 Boxes	0.97
MXK14J	78103559526/jar		Same as above but in a jar	Jar	36 Jars	0.96
MXK516	78103519527/box	5/16 Heavy Duty	50 5/16 Plastic Anchors 50 #12 X 1-1/4 Pan Cmb HD Screw Zinc 1 5/16 X 4 Masonry Drill	Box	50 Boxes	0.84
MXK516J	78103559527/jar		Same as above but in a jar	Jar	12 Jars	0.77



* Jar version part number shown. Box and Bulk versions may be available. Contact Selecta for availability, part number and pricing.
[◇] Other quantities per individual package may be available. Contact Selecta for details.

The Wall-Dog™ Universal Light Duty Screw Anchor



CATALOG NUMBER*	UPC NUMBER	DESCRIPTION	STD PAK [◇] PCS/PKG	PKG STYLE*	CASE QTY	WEIGHT/PKG (lbs.)
WDOGJ	78103569467	Chrome pan head phillips anchors	100	Jar	48 Jars	0.80
*WDOG/BJ	78103569466	Chrome pan head phillips anchors with 3/16 x 4" masonry bit	100	Jar	48 Jars	0.83
WDOGWJ	78103568468	White pan head phillips anchors	100	Jar	48 Jars	0.79
*WDOGW/BJ	78103568469	White pan head phillips anchors with 3/16 x 4" masonry bit	100	Jar	48 Jars	0.81
WDOGOVJ	78103568470	Chrome oval head phillips anchors	100	Jar	48 Jars	0.80
*WDOGOV/BJ	78103568471	Chrome oval head phillips anchors with 3/16" x 4" masonry bit	100	Jar	48 Jars	0.81
WDOGOVWJ	78103568472	White oval head phillips anchors	100	Jar	48 Jars	0.79
*WDOGOVW/BJ	78103568473	White oval head phillips anchors with 3/16 x 4" masonry bit	100	Jar	48 Jars	0.81

Features:

- Installs in wallboard, plywood, concrete, hollow or grout-filled block, brick and plaster
- No second step, installs directly through fixture into wallboard
- Patented design provides for smooth entry, clean cutting and a powerful hold
- When removed it leaves a much smaller hole than toggles or other systems

ProFast All-Purpose Lip-Anchor



CATALOG NUMBER*	UPC NUMBER	SCREW SIZE	HOLE SIZE	STD PAK [◇] PCS/PKG	PKG STYLE*	CASE QTY	WEIGHT/PKG (lbs.)
WA14PFJ	78103519560	6-8-10-12	1/4	100	Jar	48 Jars	0.20



CATALOG NUMBER*	UPC NUMBER	SIZE	CONTENTS	PKG STYLE*	CASE QTY	WEIGHT/PKG (lbs.)
ANCHOR WITH COMBO SCREW						
PAK14PF	78103519561	1/4	100 1/4 Profast Anchors All Purpose 100 #10 x 1 Pan Combo HD Screw Zinc 1 1/4 X 4 Masonry Drill	Box	50 Boxes	1.05

NOTE: Items WA14PFJ (UPC# 78103519560) and PAK14PF (UPC# 78103519561) have been discontinued. Please contact Selecta for details.

Gray Ribbed Plastic Anchor



CATALOG NUMBER*	UPC NUMBER	SCREW SIZE	HOLE SIZE	STD PAK [◇] PCS/PKG	PKG STYLE*	CASE QTY	WEIGHT/PKG (lbs.)
WAR316J	78103559570	6-8	3/16	100	Jar	48 Jars	0.10
WAR14J	78103559571	10-12	1/4	100	Jar	48 Jars	0.20
WAR516J	78103559572	14-16	5/16	100	Jar	48 Jars	0.25



CATALOG NUMBER*	UPC NUMBER	SIZE	CONTENTS	PKG STYLE*	CASE QTY	WEIGHT/PKG (lbs.)
ANCHOR WITH COMBO SCREWS						
PAK316RJ	78103559575	3/16 Light Duty	100 3/16 X 7/8 Gray Ribbed Anchor 100 #6 X 1" Pan Cmb HD Screw Zinc 1 3/16 X 4 Masonry Drill	Jar	48 Jars	0.47
PAK14RJ	78103559576	1/4 Medium Duty	100 1/4 x 1 Gray Ribbed Anchor 100 #10 X 1 Pan Cmb HD Screw Zinc 1 1/4 X 4 Masonry Drill	Jar	36 Jars	0.94
PAK516RJ	78103559577	5/16 Heavy Duty	50 5/16 x 1-3/8 Gray Ribbed Anchor 50 #12 X 1-1/4 Pan Cmb HD Screw Zinc 1 5/16 X 4 Masonry Drill	Jar	36 Jars	1.42

* Pre-drill required for concrete, hollow block, brick and plaster applications.

+ Jar version part number shown. Box and Bulk versions may be available. Contact Selecta for availability, part number and pricing.

◇ Other quantities per individual package may be available. Contact Selecta for details.

Wall Anchors + Kits • Boxes or Jars

Zip-It Anchors Nylon or Zinc Die-Cast

CATALOG NUMBER*	UPC NUMBER	SCREW SIZE	STD PAK [◇] PCS/PKG	PKG STYLE*	CASE QTY	WEIGHT/PKG (lbs.)
NYLON						
SNL1J	78103559544	#6	100	Jar	48 Jars	0.25
SN1J	78103559540	#8	100	Jar	24 Jars	0.45
ZINC						
SN2ZLJ	78103559547	#6	100	Jar	48 Jars	0.85
SN2ZJ	78103559542	#8	100	Jar	24 Jars	1.40



CATALOG NUMBER*	UPC NUMBER	MATERIAL	CONTENTS	PKG STYLE*	CASE QTY	WEIGHT/PKG (lbs.)
NYLON OR ZINC DIE-CAST SCREW-IN WITH PAN HD COMBO TAPPING SCREWS						
SNL1K	78103519545/box	Nylon	#6 Light Duty Anchor 50 6 X 1 Pan Combo HD Screws Zinc 50 Screw-In Anchors	Box	50 Boxes	0.45
SNL1KJ	78103559495/jar	Nylon	Same contents as above	Jar	48 Jars	0.30
SN2ZLK	78103519546/box	Zinc Die-Cast	Same contents as above	Box	50 Boxes	0.60
SN2ZLKJ	78103559546/jar	Zinc Die-Cast	Same contents as above	Jar	36 Jars	0.65
SN1K	78103519541/box	Nylon	#8 Medium Duty Anchor 50 8 X 1 Pan Cmbd HD Screws Zinc 50 Screw-In Anchors	Box	50 Boxes	0.60
SN1KJ	78103559541/jar	Nylon	Same contents as above	Jar	36 Jars	0.45
SN2ZK	78103519543/box	Zinc Die-Cast	Same contents as above	Box	50 Boxes	0.95
SN2ZKJ	78103559543/jar	Zinc Die-Cast	Same contents as above	Jar	36 Jars	1.00



Features:

- **FAST** - No drilling or hole preparation necessary (Saves Time and Money)
- **NEAT** - Unique tri-cut point self drills a clean hole, and head seats flush
- **EASY** - Installs quickly with a #2 Phillips driver
- **NON-METALLIC** - High strength nylon provides the safety of being non-conductive
- **REMOVABLE** - Can easily be backed out

Plastic Toggle

CATALOG NUMBER*	UPC NUMBER	SIZE & WALL THICKNESS	STD PAK [◇] PCS/PKG	PKG STYLE*	CASE QTY	WEIGHT/PKG (lbs.)
PTA38J	78103559530	3/8	100	Jar	12 Jars	0.55
PTA12J	78103559531	1/2	100	Jar	12 Jars	0.38
PTA58J	78103559532	5/8	100	Jar	12 Jars	0.59



CATALOG NUMBER*	UPC NUMBER	SIZE	CONTENTS	PKG STYLE*	CASE QTY	WEIGHT/PKG (lbs.)
PLASTIC TOGGLE ANCHOR WITH PAN HD COMBO TAPPING SCREWS						
PTAK38J	78103559534	3/8	50 3/8 Plastic Toggles 50 8 X 1-1/2 Pan Combo Screws Zinc	Jar	12 Jars	0.67
PTAK12J	78103559533	1/2	50 1/2 Plastic Toggles 50 8 X 1-1/2 Pan Combo Screws Zinc	Jar	12 Jars	0.67
PTAK58J	78103559535	5/8	50 5/8 Plastic Toggles 50 8 X 1-1/2 Pan Combo Screws Zinc	Jar	12 Jars	0.66



E-Z Toggle

CATALOG NUMBER*	UPC NUMBER	SCREW SIZE	CONTENTS	PKG STYLE*	CASE QTY	WEIGHT/PKG (lbs.)
TOGGLE ANCHOR WITH PAN HD COMBO TAPPING SCREWS						
EZT82J	78103559580	#8	50 Toggles 50 #8 X 2 Pan Head Combo Screws	Jar	36 Jars	2.01
EZT82K (box)	78103519583	#8	25 Toggles 25 #8 X 2 Pan Head Combo Screws	Box	12 Boxes	1.23
EZT82KJ (jar)	78103559585		Same as above but in a jar	Jar	36 Jars	1.19



+ Jar version part number shown. Box and Bulk versions may be available. Contact Selecta for availability, part number and pricing.
[◇] Other quantities per individual package may be available. Contact Selecta for details.

Tap-Con Type Concrete Anchoring Masonry Screws No Need for Anchor*



CATALOG NO. HEX HD*	UPC NUMBER	CATALOG NO. FLAT HD*	UPC NUMBER	DIA.	LGTH.	DRILL SIZE	STD PAK ^o PCS/PKG	PKG STYLE	CASE QTY	WT/ PKG (lbs.)
CSH316114J	78103554151	CSF316114J	78103554170	3/16	1-1/4	CMD532-312	100	Jar	48 Jars	0.80
CSH316134J	78103554152	CSF316134J	78103554171	3/16	1-3/4	CMD532-312	100	Jar	48 Jars	1.03
CSH316214J	78103554153	CSF316214J	78103554172	3/16	2-1/4	CMD532-412	100	Jar	36 Jars	1.32
CSH316234J	78103554154	CSF316234J	78103554173	3/16	2-3/4	CMD532-412	100	Jar	24 Jars	1.62
CSH316314J	78103554155	CSF316314J	78103554174	3/16	3-1/4	CMD532-512	100	Jar	12 Jars	1.88
CSH316334J	78103554167	CSF316334J	78103554177	3/16	3-3/4	CMD532-512	100	Jar	12 Jars	2.14
CSH3164J	78103554156	CSF3164J	78103554175	3/16	4	CMD532-512	100	Jar	12 Jars	2.47
CSH14114J	78103554160	CSF14114J	78103554180	1/4	1-1/4	CMD316-312	100	Jar	48 Jars	1.28
CSH14134J	78103554161	CSF14134J	78103554181	1/4	1-3/4	CMD316-312	100	Jar	36 Jars	1.71
CSH14214J	78103554162	CSF14214J	78103554182	1/4	2-1/4	CMD316-412	100	Jar	24 Jars	2.14
CSH14234J	78103554163	CSF14234J	78103554183	1/4	2-3/4	CMD316-412	50	Jar	12 Jars	1.32
CSH14314J	78103554164	CSF14314J	78103554184	1/4	3-1/4	CMD316-512	50	Jar	12 Jars	1.54
CSH14334J	78103554168	CSF14334J	78103554188	1/4	3-3/4	CMD316-512	50	Jar	12 Jars	1.76
CSH144J	78103554165	CSF144J	78103554185	1/4	4	CMD316-512	25	Jar	12 Jars	1.01
CSH145J	78103554166	CSF145J	78103554186	1/4	5	CMD316-612	25	Jar	12 Jars	1.13

Concrete/Masonry Screw Accessories



CATALOG NUMBER*	UPC NUMBER	DESCRIPTION	STD PAK ^o PCS/PKG	PKG STYLE	WEIGHT/ PKG (lbs.)
CSIT1000	78103514100	INSTALLATION TOOL (COMPLETE)	1	Box	0.95
CSHK-1	78103514099	1/8" Allen Hex Key	1	Bag	0.11
CSMHD14	78103514102	1/4" Magnetic Hex Driver	1	Bag	0.13
CSMHD516	78103514103	5/16" Magnetic Hex Driver	1	Bag	0.16
CSPHH-2-3	78103514104	#2 - #3 Phillips Bit Holder	1	Bag	0.12

Concrete Screw Accessory Drills



CATALOG NUMBER	UPC NUMBER	SIZE	STD PAK ^o PCS/PKG	PKG STYLE	WEIGHT/ PKG (lbs.)
CMD532-312	78103514305	5/32 X 3-1/2	1	Bag	0.03
CMD532-412	78103514306	5/32 X 4-1/2	1	Bag	0.03
CMD532-512	78103514307	5/32 X 5-1/2	1	Bag	0.03
CMD316-312	78103514309	3/16 X 3-1/2	1	Bag	0.03
CMD316-412	78103514310	3/16 X 4-1/2	1	Bag	0.03
CMD316-512	78103514311	3/16 X 5-1/2	1	Bag	0.04
CMD316-612	78103514312	3/16 X 6-1/2	1	Bag	0.05

* One drill packaged with every jar of 100.

+ Jar version part number shown. Box and Bulk versions may be available. Contact Selecta for availability, part number and pricing.

o Other quantities per individual package may be available. Contact Selecta for details.

Machine Screw Lead Anchors One Setting Tool Furnished in Each Box of Anchors

CATALOG NUMBER*	UPC NUMBER	SIZE	DRILL DIAMETER	ANCHOR LENGTH	STD PAK [◇] PCS/PKG	PKG STYLE*	CASE QTY	WEIGHT/PKG (lbs.)
MSA6J	78103559703	6-32	5/16	19/32	100	Jar	48 Jars	0.87
MSA8J	78103559704	8-32	5/16	17/32	100	Jar	48 Jars	0.91
MSA102J	78103559705	10-24	3/8	11/16	100	Jar	48 Jars	2.00
MSA14J	78103559707	1/4-20	1/2	7/8	100	Jar	24 Jars	3.77
MSA516J	78103559708	5/16-18	5/8	1-1/16	100	Jar	12 Jars	4.71
MSA38J	78103559709	3/8-16	3/4	1-5/16	50	Jar	12 Jars	5.15
MSA12J	78103559710	1/2-13	7/8	1-9/16	25	Jar	12 Jars	4.23



Machine Screw Anchor Setting Tool

CATALOG NUMBER*	UPC NUMBER	SIZE	STD PAK [◇] PCS/PKG	PKG STYLE*	WEIGHT/PKG (lbs.)
MST6	78103519715	6-32	1	Bag	0.04
MST8	78103519716	8-32	1	Bag	0.07
MST102	78103519717	10-24	1	Bag	0.08
MST14	78103519719	1/4-20	1	Bag	0.17
MST516	78103519720	5/16-18	1	Bag	0.27
MST38	78103519721	3/8-16	1	Bag	0.38
MST12	78103519722	1/2-13	1	Bag	0.58



Steel Drop-In Anchors* • Zinc Plated One Setting Tool Furnished in Each Jar of Anchors

CATALOG NUMBER*	UPC NUMBER	SIZE	DRILL DIAMETER	ANCHOR LENGTH	STD PAK [◇] PCS/PKG	PKG STYLE*	CASE QTY	WEIGHT/PKG (lbs.)
SDIA14J	78103559730	1/4-20	3/8	1"	100	Jar	36 Jars	2.28
SDIA38J	78103559731	3/8-16	1/2	1-9/16"	50	Jar	24 Jars	3.25
SDIA12J	78103559732	1/2-13	5/8	2"	50	Jar	12 Jars	6.30



Drop-In Anchor Setting Tool

CATALOG NUMBER*	UPC NUMBER	SIZE	STD PAK [◇] PCS/PKG	PKG STYLE*	WEIGHT/PKG (lbs.)
SDIAT14	78103519740	1/4	1	Bag	0.18
SDIAT38	78103519741	3/8	1	Bag	0.24
SDIAT12	78103519742	1/2	1	Bag	0.41



Self-Drilling Anchors

CATALOG NUMBER*	UPC NUMBER	SIZE	OUTSIDE DIAMETER	OVERALL LENGTH	THREAD DEPTH	STD PAK [◇] PCS/PKG	PKG STYLE*	CASE QTY	WEIGHT/PKG (lbs.)
SDA14J	78103559830	1/4"	7/16"	17/32"	1/2"	100	Jar	24 Jars	4.81
SDA516J	78103559831	5/16"	1/2"	1-7/16"	9/16"	100	Jar	12 Jars	5.02
SDA38J	78103559832	3/8"	9/16"	1-1/2"	5/8"	50	Jar	12 Jars	5.15
SDA12J	78103559833	1/2"	11/16"	2"	7/8"	25	Jar	12 Jars	4.88



* Stainless steel available upon request.

+ Jar version part number shown. Box and Bulk versions may be available. Contact Selecta for availability, part number and pricing.

◇ Other quantities per individual package may be available. Contact Selecta for details.

Sleeve Anchor* Acorn Nut, Zinc-Plated Steel



CATALOG NUMBER*	UPC NUMBER	SIZE	DRILL SIZE	STD PAK [◇] PCS/PKG	PKG STYLE*	CASE QTY	WEIGHT/PKG (lbs.)
SA14138J	78103567003	1/4 X 1-3/8	1/4	100	Jar	24 Jars	2.32
SA14214J	78103567001	1/4 X 2-1/4	1/4	100	Jar	12 Jars	3.14

Sleeve Anchor* Hex Nut, Zinc-Plated Steel



CATALOG NUMBER*	UPC NUMBER	SIZE	DRILL SIZE	STD PAK [◇] PCS/PKG	PKG STYLE*	CASE QTY	WEIGHT/PKG (lbs.)
SA516112J	78103567005	5/16 X 1-1/2	5/16	100	Jar	12 Jars	4.00
SA516212J	78103567006	5/16 X 2-1/2	5/16	100	Jar	12 Jars	6.03
SA38178J	78103567007	3/8 X 1-7/8	3/8	50	Jar	12 Jars	3.30
SA383J	78103567008	3/8 X 3	3/8	50	Jar	12 Jars	5.06
SA12214J	78103567009	1/2 X 2-1/4	1/2	25	Jar	24 Jars	3.11
SA123J	78103567010	1/2 X 3	1/2	25	Jar	12 Jars	4.11
SA58214J	78103567011	5/8 X 2-1/4	5/8	25	Jar	12 Jars	6.60
SA58414J	78103567012	5/8 X 4-1/4	5/8	10	Jar	12 Jars	4.14
SA58534J	78103567013	5/8 X 5-3/4	5/8	10	Jar	12 Jars	5.16
SA34212J	78103567014	3/4 X 2-1/2	3/4	10	Jar	12 Jars	4.48
SA34414J	78103567015	3/4 X 4-1/4	3/4	5	Jar	12 Jars	3.23
SA34614J	78103567016	3/4 X 6-1/4	3/4	5	Jar	12 Jars	4.75

Zinc Hammer Drive Nail-In Anchor



CATALOG NUMBER*	UPC NUMBER	SIZE	DRILL SIZE	STD PAK [◇] PCS/PKG	PKG STYLE*	CASE QTY	WEIGHT/PKG (lbs.)
HDA316J	78103559450	3/16 X 7/8	3/16	100	Jar	48 Jars	0.99
HDA1434J	78103559455	1/4 X 3/4	1/4	100	Jar	48 Jars	1.57
HDA141J	78103559451	1/4 X 1	1/4	100	Jar	24 Jars	1.78
HDA14114J	78103559452	1/4 X 1-1/4	1/4	100	Jar	24 Jars	2.19
HDA14112J	78103559453	1/4 X 1-1/2	1/4	100	Jar	12 Jars	2.53
HDA142J	78103559454	1/4 X 2	1/4	100	Jar	12 Jars	2.91

Nylon Hammer Drive Nail-In Anchors*



CATALOG NO. ROUND HD*	UPC NUMBER	CATALOG NO. TRUSS HD*	UPC NUMBER	SIZE	STD PAK [◇] PCS/PKG	PKG STYLE*	CASE QTY	WEIGHT/PKG (lbs.)
RNA3161J	78103559515	TNA3161J	78103559550	3/16 X 1	100	Jar	48 Jars	0.57
RNA31615J	78103559516	TNA31615J	78103559551	3/16 X 1-1/2	100	Jar	12 Jars	0.78
RNA141J	78103559517	TNA141J	78103559552	1/4 X 1	100	Jar	36 Jars	0.60
RNA1415J	78103559518	TNA1415J	78103559553	1/4 X 1-1/2	100	Jar	24 Jars	0.82

Tie Wire Wedge Anchor With Stainless Steel Clip For Various Overhead Suspension Applications



CATALOG NUMBER*	UPC NUMBER	SIZE	DRILL HOLE DIA & DEPTH	STD PAK [◇] PCS/PKG	PKG STYLE*	CASE QTY	WEIGHT/PKG (lbs.)
TWWA214J	78103559980	1/4 X 2-1/4	1/4 X 1-3/8"	100	Jar	24 Jars	3.47

* Round and/or flat head available upon request.

† Jar version part number shown. Box and Bulk versions may be available. Contact Selecta for availability, part number and pricing.

◇ Other quantities per individual package may be available. Contact Selecta for details.

Popular Size Wedge Anchors^{△*} Zinc-Plated Steel

CATALOG NUMBER*	UPC NUMBER	SIZE	USE DRILL SIZE	FASTENS MAT'L UP TO	STD PAK [◇] PCS/PKG	PKG STYLE*	CASE QTY	WEIGHT / PKG (lbs.)
WEG14134J	78103559900	1/4 X 1-3/4	1/4"	3/16"	100	Jar	24 Jars	3.10
WEG14214J	78103559901	1/4 X 2-1/4	1/4"	5/8"	100	Jar	12 Jars	3.56
WEG14314J	78103559902	1/4 X 3-1/4	1/4"	1-1/2"	100	Jar	12 Jars	4.52
WEG38214J	78103559903	3/8 X 2-1/4	3/8"	1/8"	100	Jar	12 Jars	7.93
WEG38234J	78103559904	3/8 X 2-3/4	3/8"	1/2"	100	Jar	12 Jars	9.72
WEG383J	78103559905	3/8 X 3	3/8"	3/4"	100	Jar	12 Jars	9.83
WEG38334J	78103559906	3/8 X 3-3/4	3/8"	1-1/2"	50	Jar	12 Jars	5.80
WEG385J	78103559907	3/8 X 5	3/8"	2-3/4"	50	Jar	12 Jars	7.35
WEG12234J	78103559908	1/2 X 2-3/4	1/2"	1/8"	50	Jar	12 Jars	8.90
WEG12334J	78103559910	1/2 X 3-3/4	1/2"	7/8"	50	Jar	12 Jars	11.08
WEG12414J	78103559911	1/2 X 4-1/4	1/2"	1-1/2"	25	Jar	12 Jars	3.07
WEG12512J	78103559912	1/2 X 5-1/2	1/2"	2-1/2"	25	Jar	12 Jars	7.44
WEG127J	78103559913	1/2 X 7	1/2"	4"	25	Jar	12 Jars	9.34
WEG58312J	78103559914	5/8 X 3-1/2	5/8"	3/16"	25	Jar	12 Jars	9.22
WEG58412J	78103559915	5/8 X 4-1/2	5/8"	1-1/8"	25	Jar	12 Jars	11.00
WEG585J	78103559916	5/8 X 5	5/8"	1-1/2"	25	Jar	12 Jars	11.60
WEG586J	78103559917	5/8 X 6	5/8"	2-1/2"	20	Jar	12 Jars	10.50
WEG34414J	78103559918	3/4 X 4-1/4	3/4"	1/2"	20	Jar	12 Jars	12.35
WEG34434J	78103559919	3/4 X 4-3/4	3/4"	3/4"	20	Jar	12 Jars	13.27
WEG34512J	78103559920	3/4 X 5-1/2	3/4"	1-1/2"	20	Jar	12 Jars	15.60
WEG34614J	78103559921	3/4 X 6-1/4	3/4"	3"	10	Jar	12 Jars	8.25



Hammer Drive Wedge Anchor Zinc & Yellow Chromate

CATALOG NUMBER*	UPC NUMBER	SIZE	USE DRILL SIZE	FASTENS MAT'L UP TO	STD PAK [◇] PCS/PKG	PKG STYLE*	CASE QTY	WEIGHT / PKG (lbs.)
HDWA14134J	78103559930	1/4 X 1-3/4	1/4	1/2"	100	Jar	12 Jars	3.23
HDWA14238J	78103559931	1/4 X 2-3/8	1/4	7/8"	100	Jar	12 Jars	3.92
HDWA5162J	78103559932	5/16 X 2	5/16	1-1/4	100	Jar	12 Jars	4.14
HDWA516234J	78103559933	5/16 X 2-3/4	5/16	1-1/4"	100	Jar	12 Jars	6.08
HDWA5164J	78103559934	5/16 X 4	5/16	2-1/2"	100	Jar	12 Jars	7.39
HDWA38238J	78103559935	3/8 X 2-3/8	3/8	5/8"	100	Jar	12 Jars	8.54
HDWA38312J	78103559936	3/8 X 3-1/2	3/8	1-3/4"	100	Jar	12 Jars	12.10
HDWA385J	78103559937	3/8 X 5	3/8	3-1/4"	50	Jar	12 Jars	7.15
HDWA12234J	78103559938	1/2 X 2-3/4	1/2	3/4"	50	Jar	12 Jars	9.60
HDWA12312J	78103559939	1/2 X 3-1/2	1/2	1-1/2"	25	Jar	12 Jars	5.88
HDWA12434J	78103559940	1/2 X 4-3/4	1/2	2-3/4"	25	Jar	12 Jars	7.38
HDWA126	78103559941	1/2 X 6	1/2	4"	30	Box	N/A	10.88
HDWA584	78103559942	5/8 X 4	5/8	1-1/2"	30	Box	N/A	12.91
HDWA58434	78103559943	5/8 X 4-3/4	5/8	2-3/8"	25	Box	N/A	12.22
HDWA586J	78103559944	5/8 X 6	5/8	3-1/2"	25	Jar	12 Jars	15.08
HDWA345	78103559945	3/4 X 5	3/4	2-1/4"	20	Box	N/A	14.72
HDWA346	78103559946	3/4 X 6	3/4	3-1/4"	20	Box	N/A	16.78



**A superior alternative
to traditional wedge anchors**
ICBO APPROVED

**Safety glasses should be worn
for any driving applications.**

INSTALLATION:

1. Drill hole.
2. Preset nut and washer for desired embedment.
3. Hammer center pin until it is aligned with top of the bolt.
4. Anchor is set.

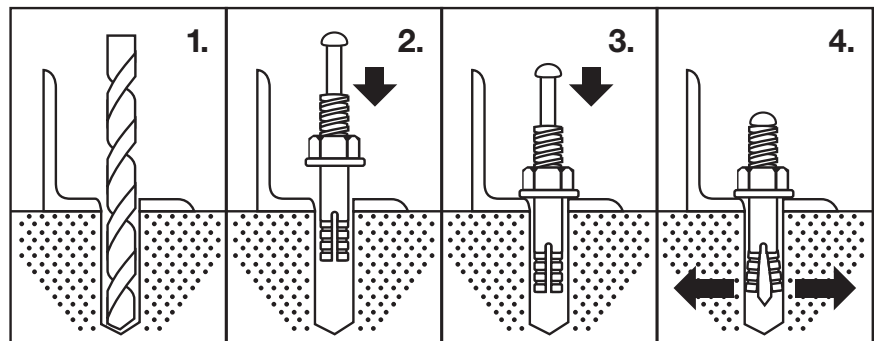

[△]Other sizes available upon request.

* Stainless steel available upon request.

+ Jar version part number shown. Box and Bulk versions may be available. Contact Selecta for availability, part number and pricing.

[◇] Other quantities per individual package may be available. Contact Selecta for details.

Hollow Block T-Anchors • Steel, Zinc Chromate For Hollow Wallblock



ICBO APPROVED

CATALOG NUMBER*	UPC NUMBER	SIZE	USE DRILL SIZE	FASTENS MAT'L UP TO	STD PAK [◇] PCS/PKG	PKG STYLE*	CASE QTY	WEIGHT/PKG (lbs.)
HBTA14134J	78103559960	1/4 X 1-3/4	5/16	1"	100	Jar	24 Jars	3.72
HBTA14212J	78103559961	1/4 X 2-1/2	5/16	1 - 1-3/4"	100	Jar	12 Jars	4.48
HBTA14314J	78103559962	1/4 X 3-1/4	5/16	1 - 2-1/2"	100	Jar	12 Jars	3.56
HBTA516212J	78103559963	5/16 X 2-1/2	5/16	7/8 - 1-1/2"	100	Jar	12 Jars	6.40
HBTA516314J	78103559964	5/16 X 3-1/4	5/16	1-1/4 - 2-1/4"	100	Jar	12 Jars	8.12
HBTA516334J	78103559965	5/16 X 3-3/4	5/16	1-7/8 - 2-3/4"	100	Jar	12 Jars	9.24
HBTA38314J	78103559966	3/8 X 3-1/4	3/8	1 - 2"	50	Jar	12 Jars	5.76
HBTA38334J	78103559967	3/8 X 3-3/4	3/8	1-7/8 - 2-1/2"	50	Jar	12 Jars	6.10
HBTA384J	78103559968	3/8 X 4	3/8	2 - 2-3/4"	50	Jar	12 Jars	6.44
HBTA38412J	78103559969	3/8 X 4-1/2	3/8	1/8 - 3-1/8"	50	Jar	12 Jars	7.18

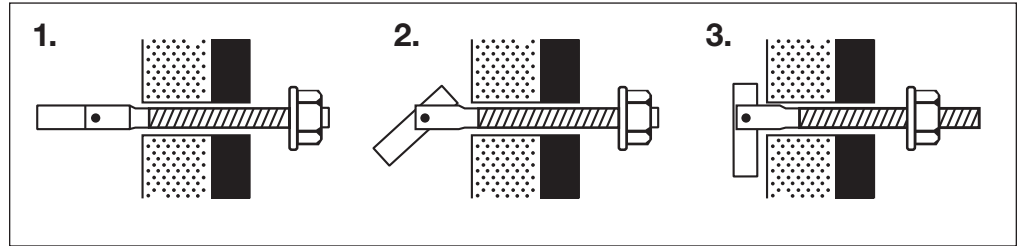

1. Drill hole using proper diameter and insert T anchor with washer and hex nut attached through item to be fastened.
2. Give it a quarter turn and retaining bar drops into place.
3. Tighten nut until a firm resistance is attained.

Double Expansion Shields • Zinc Alloy



CATALOG NUMBER*	UPC NUMBER	SIZE	HOLE SIZE	ANCHOR BODY LENGTH	STD PAK [◇] PCS/PKG	PKG STYLE*	CASE QTY	WEIGHT/PKG (lbs.)
DES14J	78103559820	1/4"	1/2	1"	100	Jar	12 Jars	3.52
DES516J	78103559821	5/16"	5/8	1-1/4"	50	Jar	24 Jars	2.78
DES38J	78103559822	3/8"	3/4	1-1/2"	50	Jar	12 Jars	4.13
DES12J	78103559823	1/2"	7/8	2"	25	Jar	12 Jars	3.80

Wood Screw Lead Anchors



CATALOG NUMBER*	UPC NUMBER	SIZE	HOLE SIZE	STD PAK [◇] PCS/PKG	PKG STYLE*	CASE QTY	WEIGHT/PKG (lbs.)
LWSA6834J	78103559950	6-8 X 3/4	1/4"	100	Jar	48 Jars	1.12
LWSA681J	78103559951	6-8 X 1	1/4"	100	Jar	48 Jars	1.47
LWSA68112J	78103559952	6-8 X 1-1/2	1/4"	100	Jar	36 Jars	2.10
LWSA101434J	78103559953	10-14 X 3/4	5/16"	100	Jar	36 Jars	1.55
LWSA10141J	78103559954	10-14 X 1	5/16"	100	Jar	36 Jars	2.00
LWSA1014112J	78103559955	10-14 X 1-1/2	5/16"	100	Jar	24 Jars	2.72
LWSA16181J	78103559956	16-18 X 1	3/8"	100	Jar	36 Jars	2.46
LWSA1618112J	78103559957	16-18 X 1-1/2	3/8"	100	Jar	36 Jars	3.59

* Jar version part number shown. Box and Bulk versions may be available. Contact Selecta for availability, part number and pricing.
[◇] Other quantities per individual package may be available. Contact Selecta for details.

Selecta Kit Korner

18 kits of popular screws, nuts, and washers in re-fillable, plastic, waterproof, six compartment boxes.
All kits can be private labeled at no charge.

CATALOG NUMBER	UPC NUMBER	SHEET METAL SCREWS DESCRIPTION OF CONTENTS	PKG STYLE	WEIGHT/ PKG (lbs.)
AKPC8	78103522100	# 8 PAN HD COMBO, 1 - #2 PHILLIPS POWER BIT 100 - 1/2", 75 - 3/4", 50 - 1" 30 - 1-1/4", 25 - 1-1/2", 20 - 2"	Box	1.66
AKPC10	78103522101	#10 PAN HD COMBO, 1 - #2 PHILLIPS POWER BIT 75 - 1/2", 50 - 3/4", 45 - 1" 30 - 1-1/4", 25 - 1-1/2", 20 - 2"	Box	1.84
AKHWS8	78103522110	#8 HEX SLOT WASHER, 1-1/4" NUT DRIVER 100 - 1/2", 75 - 3/4", 45 - 1" 30 - 1-1/4", 25 - 1-1/2", 20 - 2"	Box	1.69
AKHWS10	78103522111	#10 HEX SLOT WASHER, 1-5/16" NUT DRIVER 75 - 1/2", 50 - 3/4", 45 - 1" 30 - 1-1/4", 25 - 1-1/2", 20 - 2"	Box	1.90
AKPSQ8	78103522120	#8 PAN HD SQUARE DRIVE, 1 - #2 SQUARE DRIVE BIT 100 - 1/2", 75 - 3/4", 50 - 1" 30 - 1-1/4", 25 - 1-1/2", 20 - 2"	Box	1.50
AKPSQ10	78103522121	#10 PAN HD SQUARE DRIVE, 1 - #2 SQUARE DRIVE BIT 75 - 1/2", 50 - 3/4", 45 - 1" 30 - 1-1/4", 25 - 1-1/2", 20 - 2"	Box	1.95

CATALOG NUMBER	UPC NUMBER	SELF DRILLING SCREWS DESCRIPTION OF CONTENTS	PKG STYLE	WEIGHT/ PKG (lbs.)
AKTKH810	78103522130	#8 - 10 HEX WASHER, 1-1/4" DRIVER, 1-5/16" DRIVER #8 - 100 - 1/2", 50 - 3/4", 40 - 1" #10 - 50 - 1/2", 35 - 3/4", 30 - 1"	Box	1.85
AKTKP810	78103522134	#8 - 10 PAN PHIL DRIVE, 1 - #2 PHILLIPS POWER BIT #8 - 100 - 1/2", 50 - 3/4", 50 - 1" #10 - 80 - 1/2", 50 - 3/4", 40 - 1"	Box	1.85
AKTKSQ810	78103522138	#8 - 10 PAN SQUARE DRIVE, 1 - #2 SQUARE POWER BIT #8 - 100 - 1/2", 60 - 3/4", 50 - 1" #10 - 80 - 1/2", 50 - 3/4", 40 - 1"	Box	1.18

CATALOG NUMBER	UPC NUMBER	MACHINE SCREWS DESCRIPTION OF CONTENTS	PKG STYLE	WEIGHT/ PKG (lbs.)
AKFH632	78103522140	6 - 32 FLAT HEAD SLOTTED 100 - 3/4", 75 - 1", 75 - 1-1/4" 50 - 1-1/2", 40 - 2", 30 - 3"	Box	1.86
AKRHC832	78103522145	8 - 32 ROUND HEAD COMBO 100 - 1/2", 75 - 3/4", 75 - 1" 50 - 1-1/4", 40 - 1-1/2", 30 - 2"	Box	2.28
AKRHC1032	78103522147	10 - 32 ROUND HEAD COMBO 75 - 1/2", 50 - 3/4", 40 - 1" 30 - 1-1/4", 25 - 1-1/2", 25 - 2"	Box	2.18
AKRHC1420	78103522149	1/4 - 20 ROUND HEAD COMBO 35 - 1/2", 30 - 3/4", 20 - 1" 15 - 1-1/4", 12 - 1-1/2", 12 - 2"	Box	2.04

CATALOG NUMBER	UPC NUMBER	HEX NUTS - FLAT & LOCK WASHERS DESCRIPTION OF CONTENTS	PKG STYLE	WEIGHT/ PKG (lbs.)
AKHN	78103522150	HEXAGON NUTS 100 - 6-32, 100 - 8-32, 100 - 10-32 50 - 1/4-20, 30 - 5/16-18, 20 - 3/8-16	Box	1.96
AKSAE	78103522160	FLAT SAE WASHERS 100 - #6, 100 - #8, 100 - #10 75 - 1/4", 35 - 3/8", 25 - 1/2"	Box	1.75
AKLW	78103522170	MEDIUM SPLIT LOCK WASHERS 100 - #8, 100 - #10, 100 - 1/4" 60 - 5/16", 40 - 3/8", 25 - 1/2"	Box	1.35

CATALOG NUMBER	UPC NUMBER	SWITCH PLATE SCREWS DESCRIPTION OF CONTENTS	PKG STYLE	WEIGHT PKG (lbs.)
SPK1	78103522014	50 each 6-32 X 1/2" Ivory, White, Brown, Zinc 50 each 6-32 X 1-1/4" Flat Phillips Head Screw	Box	0.85
SPK2	78103522015	50 each 6-32 X 1/2" AND 1/4" Ivory, White 50 each 6-32 X 1-1/4" Flat Phillips Head Screw	Box	0.79

AKPC8



AKTKP810



AKFH632



AKHN



SPK1



Mechanical & Performance Requirements

Wedge Expansion Anchor



Description This anchor is a one-piece design that performs well in normal weight concrete, sand lightweight concrete and concrete over steel deck. The anchor is made up of a carbon steel body and is zinc plated. A nut, washer and expansion clip are attached.

Applications Wedge anchors are used for structural connections such as beams, columns, safety related attachment, and tension zones such as cable trays and strut and pipe supports.



Sleeve Anchors (Acorn Nut & Hex Nut)

Description The sleeve anchor is an all-steel pre-assembled single unit designed for use in concrete or masonry base materials. Some anchors have an acorn nut and other have a hex nut.

Applications Uses for this anchor include door and window frames, masonry, mounting electrical fixtures, and general purpose anchoring.



Steel Drop-in Anchor

Description The steel drop-in is an all-steel, internally threaded expansion anchor that can be used in solid concrete, hard stone and solid block base materials. Once anchored into the a base material, a machine bolt is used for further securing of other product.

Applications Uses include suspending conduit, cable trays and strut, pipe supports, and suspended lighting.



Lead Machine Screw Anchor

Description The MSA is a two piece pre-assembled calking type machine bolt anchor that can be used in concrete, stone, block or brick. The anchor is made up of a lead alloy sleeve and an alloy internally-threaded expander cone.

Applications General uses for this anchor include step railings, sliding doors, shutters to name a few. However, this product is not recommended for overhead applications.

Mechanical & Performance Requirements

Hammer Drive Nail-in Anchor

Description This anchor is a two-piece fastener consisting of a tubular stem with a dome or flat fillister shaped head, and a nail which is driven through the hollow center of the stem of the anchor. It is used for light duty fastening and is not recommended for overhead jobs.

Applications The anchor can be used in concrete, block, stone or brick. Such applications include roof flashing, mechanical attachments, and electrical fixtures.



Wallboard E-Z Anchor

Description The E-Z Anchor is a one piece anchor designed for drilling into drywall board to hold light to medium duty loads. The high profile threads gives the anchor a secure hold when screwing into drywall. The anchor comes in two materials – nylon and zinc alloy.

Applications This anchor is used for mounting electrical fixtures, fastening shelves, various bathroom fixtures, etc. It's available in two sizes – for a #6 or #8 screw.



Conical Wall Anchor

Description This Wall Anchor is a plastic injection molded anchor used to secure light-weight fixtures with a sheet metal screw. Its body is resistant to corrosion from moisture.

Applications Best used to hold fixtures in concrete, block and brick.



Combo Slot/Phillips • Hex Washer Head Green Grounding Screw

CATALOG NUMBER*	UPC NUMBER	SIZE	STD PAK [◇] PCS/PKG	PKG STYLE*	CASE QTY	WEIGHT/PKG (lbs.)
GS1038J	78103562004	10-32 X 3/8	100	Jar	48 Jars	0.53
GSF1038J	78103562002	10-32 X 3/8	100	Jar	48 Jars	0.56

GS - Lead Point
GSF - Thread Chasing



Grounding Clips • Green Finish

CATALOG NUMBER*	UPC NUMBER	SIZE	STD PAK [◇] PCS/PKG	PKG STYLE*	CASE QTY	WEIGHT/PKG (lbs.)
GC10J	78103562003	10-12-14 Copper or Aluminum Wire	100	Jar	48 Jars	0.41



Grounding Pig Tails

CATALOG NUMBER	UPC NUMBER	SIZE	STD PAK [◇] PCS/PKG	PKG STYLE	WEIGHT/PKG (lbs.)
WITH GREEN GROUNDING SCREW ATTACHED TO SOLID COPPER INSULATED WIRE 6-1/2"					
PT14	78103522015	#14 Wire	50	Box	0.79
PT12	78103522013	#12 Wire	50	Box	1.02
WITH GREEN GROUNDING SCREW ATTACHED TO BARE SOLID COPPER WIRE 6-1/2"					
PTB14	78103522017	#14 Wire	50	Box	0.74
PTB12	78103522016	#12 Wire	50	Box	0.94
WITH GREEN GROUNDING SCREW ATTACHED TO STRANDED COPPER INSULATED WIRE 8"					
PTS14	78103522021	#14 Wire	50	Box	0.79
PTS12	78103522020	#12 Wire	50	Box	1.45



Box Supports

CATALOG NUMBER	UPC NUMBER	DESCRIPTION	STD PAK [◇] PCS/PKG	PKG STYLE	WEIGHT/PKG (lbs.)
BS1	78103522012	Switch Box Holders	100 Pair	Box	2.69



Nail Plates

CATALOG NUMBER	UPC NUMBER	DESCRIPTION	STD PAK [◇] PCS/PKG	PKG STYLE	WEIGHT/PKG (lbs.)
NP1	78103522005	.060 X 1-1/2 X 3	100	Box	6.75
NP615	78103522006	.060 X 1-1/2 X 6-1/2	100	Box	10.70



+ Jar version part number shown. Box and Bulk versions may be available. Contact Selecta for availability, part number and pricing.
[◇] Other quantities per individual package may be available. Contact Selecta for details.

Accessory Wall Plate Screws

Switch Plate Screws

Almond • Ivory • White • Brown • Brass • Nickel • Stainless



CATALOG NUMBER*	UPC NUMBER	SIZE	COLOR	STD PAK [◇] PCS/PKG	PKG STYLE*	CASE QTY	WEIGHT/PKG (lbs.)
SLOTTED OVAL HEAD STEEL WALL PLATE SCREWS							
SP6ALJ	63290910116	6-32 X 1/2	Almond	100	Jar	48 Jars	0.28
SP6IJ	78103562007	6-32 X 1/2	Ivory	100	Jar	48 Jars	0.28
SP6WJ	78103562008	6-32 X 1/2	White	100	Jar	48 Jars	0.28
SP6BNJ	78103562009	6-32 X 1/2	Brown	100	Jar	48 Jars	0.29
SP6BRJ	78103562010	6-32 X 1/2	Brass	100	Jar	48 Jars	0.30
SP6NJ	78103562011	6-32 X 1/2	Nickel	100	Jar	48 Jars	0.29
SP6SSJ	78103562019	6-32 X 1/2	Stainless	100	Jar	48 Jars	0.27
SP634IJ	63290910109	6-32 X 3/4	Ivory	100	Jar	48 Jars	0.35
SP634WJ	63290910108	6-32 X 3/4	White	100	Jar	48 Jars	0.37
SP634BJ	78103581355	6-32 X 3/4	Brown	100	Jar	48 Jars	0.35
SP634SSJ	78103581356	6-32 X 3/4	Stainless	100	Jar	48 Jars	0.34
SP61IJ	63290910111	6-32 X 1	Ivory	100	Jar	48 Jars	0.43
SP61WJ	63290910110	6-32 X 1	White	100	Jar	48 Jars	0.43
SP61BJ	78103581357	6-32 X 1	Brown	100	Jar	48 Jars	0.43
SP61SSJ	78103581358	6-32 X 1	Stainless	100	Jar	48 Jars	0.43
SP62IJ	78103581359	6-32 X 2	Ivory	100	Jar	48 Jars	0.72
SP62WJ	78103581360	6-32 X 2	White	100	Jar	48 Jars	0.72
SP62SSJ	78103581361	6-32 X 2	Stainless	100	Jar	48 Jars	0.71
*SPD614IJ	78103562041	6-32 X 1/4	Ivory	100	Jar	48 Jars	0.26
*SPD614WJ	78103562042	6-32 X 1/4	White	100	Jar	48 Jars	0.21
STANDARD NYLON WALL PLATE SCREWS							
NSP6IJ	78103562020	6-32 X 1/2	Ivory	100	Jar	48 Jars	0.11
NSP6WJ	78103562021	6-32 X 1/2	White	100	Jar	48 Jars	0.11
NSP6BRJ	78103562022	6-32 X 1/2	Brown	100	Jar	48 Jars	0.11
TAMPER-PROOF SPANNER HEAD STAINLESS STEEL WALL PLATE SCREWS							
SP612TPSJ	78103562050	6-32 X 1/2	Stainless	100	Jar	48 Jars	0.29

Switch Plate Screw Kit

Assorted Switch Plate Screws in Reusable Plastic Box



CATALOG NUMBER	UPC NUMBER	DESCRIPTION OF CONTENTS	PKG STYLE	WEIGHT/PKG (lbs.)
SPK1	78103522014	50 Ea: 6-32 X 1/2 - Ivory 6-32 X 1/2 - White 6-32 X 1/2 - Brown 6-32 X 1/2 - Nickel 6-32 X 1-1/4 - Flat HD Phillips Zinc	Box	0.85
SPK2	78103522018	50 Ea: 6-32 X 1/2 - Ivory 6-32 X 1/2 - White *6-32 X 1/4 - Ivory *6-32 X 1/4 - White 6-32 X 1-1/4 - Flat HD Phillips Zinc	Box	0.79

* 1/4" size for decorator plates.

+ Jar version part number shown. Box and Bulk versions may be available. Contact Selecta for availability, part number and pricing.

◇ Other quantities per individual package may be available. Contact Selecta for details.

Coppered Insulated Staples for Low Voltage Wiring

CATALOG NUMBER*	UPC NUMBER	SIZE	WIDTH	LENGTH OF LEGS	STD PAK [◇] PCS/PKG	PKG STYLE*	CASE QTY	WEIGHT/PKG (lbs.)
IS1J	78103563003	#1	3/16	1/2	100	Jar	48 Jars	0.21
IS3J	78103563005	#3	3/16	3/4	100	Jar	48 Jars	0.28
IS5J	78103563006	#5	1/4	5/8	100	Jar	48 Jars	0.23
IS6J	78103563007	#6	1/4	3/4	100	Jar	48 Jars	0.25
IS7J	78103563008	#7	1/4	7/8	100	Jar	48 Jars	0.27

Conform to U.S. Government Specifications

NOTE: Item IS10J (UPC# 78103563009) has been discontinued. Please contact Selecta for details.



Cable Staples For Romex, BX, S.E.U. & Other Cables

CATALOG NUMBER*	UPC NUMBER	USE	LENGTH X WIDTH	STD PAK [◇] PCS/PKG	PKG STYLE*	CASE QTY	WEIGHT/PKG (lbs.)
CS40J	78103563010	N,M,C COND	1 X 1/2	100	Jar	48 Jars	0.64
FCS40J	78103563011	14 + 12	1 X 1/2	500	Jar	12 Jars	2.14
BCS40	78103563012	2 COND W.G.	1 X 1/2	10,000	Pail	N/A	26.95
CS100J	78103563013	B X 3 COND	1-1/4 X 9/16	100	Jar	48 Jars	0.69
FCS100J	78103563014	14-12 + 10	1-1/4 X 9/16	500	Jar	12 Jars	2.95
BCS100	78103563015		1-1/4 X 9/16	5000	Pail	N/A	35.9
CS300J	78103563016	6/3 Service Cable 8/3 Armoured L/3 Non-Metallic	1-3/8 X 13/16	100	Jar	36 Jars	1.27
CS350J	78103563017	4/3 Service 2/3 Service 3/4" EMT	1-1/2 X 1-1/8	100	Jar	36 Jars	1.34



Insulated Cable Staples With PVC Insulator

CATALOG NUMBER*	UPC NUMBER	USE	LENGTH X WIDTH	STD PAK [◇] PCS/PKG	PKG STYLE*	CASE QTY	WEIGHT/PKG (lbs.)
ICS40J	78103563018	Non-Metallic	1 X 1/2	100	Jar	36 Jars	0.57
ICS40FJ	78103563019		1 X 1/2	500	Jar	24 Jars	2.93
ICS40B	78103563020	12 & 14 Wire	1 X 1/2	4,000	Pail	N/A	22.62



Plastic Cable Strap Nail-In Designed to Prevent Cable Damage

CATALOG NUMBER*	UPC NUMBER	USE	WIDTH	STD PAK [◇] PCS/PKG	PKG STYLE*	CASE QTY	WEIGHT/PKG (lbs.)
PCSNI12J	78103583090	2 & 3 Wire NM Cable Up To #12 2-Wire UF Cable Up To #12 & Other Cable Up To 1/2" Wide	1/2	100	Jar	36 Jars	0.52
PCSNI34J	78103523095	2-Wire NM & UF Cable Up To #8 3-Wire UF Cable Up To #12 & Other Cable Up To 3/4" Wide	3/4	100	Jar	24 Jars	0.57



* Jar version part number shown. Box and Bulk versions may be available. Contact Selecta for availability, part number and pricing.
[◇] Other quantities per individual package may be available. Contact Selecta for details.

Raceway & Wireway Mounting Screws Flat Phillips Hardened • Steel Zinc Plated



CATALOG NUMBER*	UPC NUMBER	DIAMETER	LENGTH	STD PAK [◇] PCS/PKG	PKG STYLE*	CASE QTY	WEIGHT/PKG (lbs.)
MS612J	78103553160	6	1/2	100	Jar	48 Jars	0.22
MS634J	78103553161	6	3/4	100	Jar	48 Jars	0.28
MS61J	78103553162	6	1	100	Jar	48 Jars	0.35
MS6114J	78103553163	6	1-1/4	100	Jar	48 Jars	0.43
MS834J	78103553164	8	3/4	100	Jar	48 Jars	0.34
MS81J	78103553165	8	1	100	Jar	48 Jars	0.48
MS8114J	78103553166	8	1-1/4	100	Jar	48 Jars	0.61
MS8112J	78103553167	8	1-1/2	100	Jar	48 Jars	0.69

Thin Wall One-Hole Straps

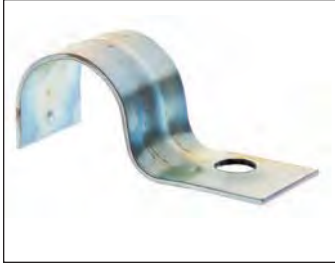

CATALOG NUMBER* EMT	UPC NUMBER	SIZE	STD PAK [◇] PCS/PKG	PKG STYLE*	WEIGHT/PKG (lbs.)
TWS12	78103559603	1/2"	100	Box	2.22
TWS34	78103559604	3/4"	100	Box	3.12
TWS1	78103559605	1"	50	Box	3.45

Conduit Drive Straps Nail Type Zinc Plated • Sizes to Accommodate



CATALOG NUMBER*	UPC NUMBER	EMT	PIPE	FLEX C	O.L.	STD PAK [◇] PCS/PKG	PKG STYLE*	CASE QTY	WEIGHT/PKG (lbs.)
CDS2J	78103563025	3/8-1/2"	3/8"	3/8"	2"	100	Jar	36 Jars	1.93
CDS4J	78103563026	3/4"	1/2"	1/2"	2-1/4"	100	Jar	24 Jars	2.22
CDS6J	78103563027	1"	3/4"	3/4"	2-3/4"	100	Jar	24 Jars	2.29

Conduit Drive Straps Stamped Type Zinc Plated • Sizes to Accommodate



CATALOG NUMBER*	UPC NUMBER	EMT	PIPE	STD PAK [◇] PCS/PKG	PKG STYLE*	CASE QTY	WEIGHT/PKG (lbs.)
SDS2J	78103563031	1/2"	3/8"	100	Jar	36 Jars	1.36
SDS4J	78103563032	3/4"	1/2"	100	Jar	24 Jars	2.63
SDS6J	78103563033	1"	3/4"	100	Jar	12 Jars	3.00

Conduit Drive Straps Pressure Cast • Sizes to Accommodate



CATALOG NUMBER*	UPC NUMBER	EMT	PIPE	FLEX C	O.L.	STD PAK [◇] PCS/PKG	PKG STYLE*	CASE QTY	WEIGHT/PKG (lbs.)
PCDS2J	78103563034	3/8-1/2"	3/8"	3/8"	2"	100	Jar	24 Jars	1.70
PCDS4J	78103563035	3/4"	1/2"	1/2"	2-1/4"	100	Jar	12 Jars	2.20
PCDS6J	78103563036	1"	3/4"	3/4"	2-3/4"	100	Jar	12 Jars	2.97

* Jar version part number shown. Box and Bulk versions may be available. Contact Selecta for availability, part number and pricing.
[◇] Other quantities per individual package may be available. Contact Selecta for details.

Premium High Speed Twist Drill Bits Black and Gold Oxide Finish • Jobbers Length



CATALOG NUMBER	UPC NUMBER	SIZE	DECIMAL EQUIVALENT	STD PAK [®] PCS/PKG	PKG STYLE	WEIGHT/PKG (lbs.)
TD116A	78103563292	1/16"	0.0625	5	Bag	0.02
TD564A	78103563314	5/64"	0.0781	5	Bag	0.02
TD332A	78103563310	3/32"	0.0938	5	Bag	0.03
TD764A	78103563318	7/64"	0.1094	5	Bag	0.04
TD18A	78103563301	1/8"	0.1250	5	Bag	0.05
TD964A	78103563320	9/64"	0.1406	5	Bag	0.06
TD532A	78103563313	5/32"	0.1562	5	Bag	0.07
TD1164A	78103563291	11/64"	0.1719	5	Bag	0.09
TD316A	78103563309	3/16"	0.1875	5	Bag	0.11
TD1364A	78103563296	13/64"	0.2031	5	Bag	0.13
TD732A	78103563317	7/32"	0.2188	5	Bag	0.13
TD1564A	78103563299	15/64"	0.2344	5	Bag	0.18
TD14A	78103563297	1/4"	0.2500	5	Bag	0.21
TD1764A	78103563300	17/64"	0.2656	5	Bag	0.29
TD932A	78103563319	9/32"	0.2812	5	Bag	0.29
TD1964A	78103563302	19/64"	0.2969	5	Bag	0.33
TD516A	78103563312	5/16"	0.3125	5	Bag	0.37
TD2164A	78103563303	21/64"	0.3281	5	Bag	0.40
TD1132A	78103563290	11/32"	0.3438	5	Bag	0.45
TD2364A	78103563304	23/64"	0.3594	5	Bag	0.49
TD38A	78103563311	3/8"	0.3750	5	Bag	0.56
TD2564A	78103563305	25/64"	0.3906	5	Bag	0.61
TD1332A	78103563295	13/32"	0.4062	5	Bag	0.65
TD2764A	78103563306	27/64"	0.4219	5	Bag	0.73
TD716A	78103563315	7/16"	0.4375	5	Bag	0.83
TD2964A	78103563307	29/64"	0.4531	5	Bag	0.87
TD1532A	78103563298	15/32"	0.4688	5	Bag	0.89
TD3164A	78103563308	31/64"	0.4844	5	Bag	1.02
TD12A	78103563293	1/2"	0.5000	5	Bag	1.18



High Speed Twist Drill Bits • Jobbers Length Fractional Number

CATALOG NUMBER	UPC NUMBER	SIZE	DECIMAL EQUIVALENT	STD PAK [®] PCS/PKG	PKG STYLE	WEIGHT/PKG (lbs.)
TD116	78103525203	1/16	.0625	5	Bag	0.02
TD564	78103525204	5/64	.0781	5	Bag	0.02
TD332	78103525205	3/32	.0938	5	Bag	0.03
TD764	78103525206	7/64	.1094	5	Bag	0.04
TD18	78103525207	1/8	.1250	5	Bag	0.05
TD964	78103525208	9/64	.1406	5	Bag	0.06
TD532	78103525209	5/32	.1562	5	Bag	0.07
TD1164	78103525210	11/64	.1719	5	Bag	0.09
TD316	78103525211	3/16	.1875	5	Bag	0.11
TD1364	78103525212	13/64	.2031	5	Bag	0.13
TD732	78103525213	7/32	.2188	5	Bag	0.13
TD1564	78103525214	15/64	.2344	5	Bag	0.18
TD14	78103525215	1/4	.2500	5	Bag	0.21
TD1764	78103525216	17/64	.2656	5	Bag	0.21
TD932	78103525217	9/32	.2812	5	Bag	0.23
TD1964	78103525218	19/64	.2969	5	Bag	0.28
TD516	78103525219	5/16	.3125	5	Bag	0.35
*TD516R	78103525220	5/16	.3125	5	Bag	0.32
TD2164	78103525221	21/64	.3281	5	Bag	0.38
TD1132	78103525222	11/32	.3438	5	Bag	0.42
TD2364	78103525223	23/64	.3594	5	Bag	0.43
TD38	78103525224	3/8	.3750	5	Bag	0.53
*TD38R	78103525234	3/8	.3750	5	Bag	0.40
TD2564	78103525235	25/64	.3906	5	Bag	0.55
TD1332	78103525236	13/32	.4062	5	Bag	0.58
TD2764	78103525237	27/64	.4219	5	Bag	0.68
TD716	78103525238	7/16	.4375	5	Bag	0.80
*TD716R	78103525239	7/16	.4375	5	Bag	0.70
TD2964	78103525240	29/64	.4531	5	Bag	0.74
TD1532	78103525241	15/32	.4688	5	Bag	0.83
TD3164	78103525242	31/64	.4844	5	Bag	0.88
TD12	78103525243	1/2	.5000	5	Bag	0.93
*TD12R	78103525244	1/2	.5000	5	Bag	0.71



* 1/4" reduced shank.
[®] Other quantities per individual package may be available. Contact Selecta for details.

High Speed Twist Drill Bits • Jobbers Length Numbered Sizes



CATALOG NUMBER	UPC NUMBER	SIZE	DECIMAL EQUIVALENT	STD PAK [◇] PCS/PKG	PKG STYLE	WEIGHT/PKG (lbs.)
TDN6	78103525406	#6	.2040	5	Bag	0.14
TDN7	78103525407	#7	.2010	5	Bag	0.11
TDN8	78103525408	#8	.1990	5	Bag	0.11
TDN9	78103525409	#9	.1960	5	Bag	0.12
TDN10	78103525410	#10	.1935	5	Bag	0.12
TDN11	78103525411	#11	.1910	5	Bag	0.12
TDN20	78103525420	#20	.1610	5	Bag	0.08
TDN21	78103525421	#21	.1590	5	Bag	0.08
TDN22	78103525422	#22	.1570	5	Bag	0.07
TDN25	78103525425	#25	.1495	5	Bag	0.07
TDN26	78103525426	#26	.1470	5	Bag	0.06
TDN28	78103525428	#28	.1405	5	Bag	0.06
TDN29	78103525429	#29	.1360	5	Bag	0.03
TDN30	78103525430	#30	.1285	5	Bag	0.03
TDN31	78103525431	#31	.1200	5	Bag	0.04
TDN35	78103525435	#35	.1100	5	Bag	0.04
TDN36	78103525436	#36	.1065	5	Bag	0.03
TDN37	78103525437	#37	.1040	5	Bag	0.04
TDN43	78103525443	#43	.0890	5	Bag	0.03

Bell Hanger Drill Bits Fish Hole in Flute for Pulling Wire



CATALOG NUMBER	UPC NUMBER	SIZE	LENGTH	STD PAK [◇] PCS/PKG	PKG STYLE	WEIGHT/PKG (lbs.)
BHD1413	78103525510	1/4	13"	1	Bag	0.17
BHD51613	78103525511	5/16	13"	1	Bag	0.24
BHD3813	78103525512	3/8	13"	1	Bag	0.32
BHD1213	78103525513	1/2	13"	1	Bag	0.38
BHD1418	78103525514	1/4	18"	1	Bag	0.26
BHD51618	78103525516	5/16	18"	1	Bag	0.37
BHD3818	78103525517	3/8	18"	1	Bag	0.54
BHD1218	78103525518	1/2	18"	1	Bag	0.56
BHD1424	78103525519	1/4	24"	1	Bag	0.34
BHD51624	78103525520	5/16	24"	1	Bag	0.53
BHD3824	78103525521	3/8	24"	1	Bag	0.73
BHD1224	78103525522	1/2	24"	1	Bag	0.78

Carbon Steel Taps • Plug Style



CATALOG NUMBER	UPC NUMBER	SIZE	USE DRILL SIZE	STD PAK [◇] PCS/PKG	PKG STYLE	WEIGHT/PKG (lbs.)
TAP440	78103525700	4-40	#43	1	Bag	0.01
TAP632	78103525701	6-32	#36	1	Bag	0.01
TAP832	78103525702	8-32	#29	1	Bag	0.01
TAP1024	78103525703	10-24	#25	1	Bag	0.03
TAP1032	78103525704	10-32	#21	1	Bag	0.02
TAP1420	78103525705	1/4-20	#8	1	Bag	0.04
TAP51618	78103525706	5/16-18	17/64	1	Bag	0.05
TAP3816	78103525707	3/8-16	5/16	1	Bag	0.08
TAP1213	78103525708	1/2-13	27/64	1	Bag	0.10

Tap Wrench • T-Handle Style



CATALOG NUMBER	UPC NUMBER	SIZE	STD PAK [◇] PCS/PKG	PKG STYLE	WEIGHT/PKG (lbs.)
TTW1	78103525721	#0-1/4"	1	Bag	0.15
TTW3	78103525722	#10-1/2"	1	Bag	0.39

[◇] Other quantities per individual package may be available. Contact Selecta for details.

Premium & Regular High Speed Twist Drill Bit Dispenser Cases with Lock

CATALOG NUMBER	UPC NUMBER	DESCRIPTION	STD PAK PCS/PKG	PKG STYLE	WEIGHT/PKG (lbs.)
TDD210	78103563321	Twist Drill Bit Display Case Set with Drill Bits 10 each 1/16", 5/64", 3/32", 7/64", 1/8", 9/64", 5/32", 11/64", 3/16", 13/64", 7/32", 15/64", 1/4"; 5 each 17/64", 9/32", 19/64", 5/16", 21/64", 11/32", 23/64", 3/8", 25/64", 13/32", 27/64", 7/16", 29/64", 15/32", 31/64", 1/2"	1 Set	Metal Case	21.72
TDD210A	78103581563	Premium* Twist Drill Bit Display Case Set with Drill Bits 10 each 1/16", 5/64", 3/32", 7/64", 1/8", 9/64", 5/32", 11/64", 3/16", 13/64", 7/32", 15/64", 1/4"; 5 each 17/64", 9/32", 19/64", 5/16", 21/64", 11/32", 23/64", 3/8", 25/64", 13/32", 27/64", 7/16", 29/64", 15/32", 31/64", 1/2"	1 Set	Metal Case	21.72
TDDC329	78103563322	Twist Drill Bit Display Case w/Lock (Drill Bits not included)	1 Case	Metal Case	9.34



TDDC329

High Speed Drill Bit Sets In Metal Index Case

CATALOG NUMBER	UPC NUMBER	DESCRIPTION	STD PAK PCS/PKG	PKG STYLE	WEIGHT/PKG (lbs.)
TDK1	78103525301	13 Drill Bits: 1/16" thru 1/4" by 64ths	1 Set	Metal Case	0.80
TDK2	78103525302	15 Drill Bits: 1/16" thru 1/2" by 32nds	1 Set	Metal Case	2.08
TDK3	78103525303	29 Drill Bits: 1/16" thru 1/2" by 64ths	1 Set	Metal Case	3.12
TDK4	78103525304	60 Drill Bits: #1 thru #60 Numbered	1 Set	Metal Case	3.25



Hex Shank Drill Bit Set • 7 Piece Set For Drills & Cordless Screwdrivers

CATALOG NUMBER	UPC NUMBER	DESCRIPTION	STD PAK PCS/PKG	PKG STYLE	WEIGHT/PKG (lbs.)
HSDS7	78103525601	DRILL BITS INCLUDED: 3/16, 5/32, 1/8, 7/64, 3/32, 5/64, 1/16	1 Set	Plastic Case	0.25



Tap & Drill Bit Set • 13 Piece Set Packaged in a Durable, Molded Plastic Case

CATALOG NUMBER	UPC NUMBER	DESCRIPTION	STD PAK PCS/PKG	PKG STYLE	WEIGHT/PKG (lbs.)
TDBS13	78103525610	6 Carbon Plug Taps, Sizes S 4-40 6-32, 10-24, 10-32, 1/4-20 6 HSS Twist Drill Bits, Sizes 43, 36 29, 25, 21, 7 1 T-Handle Wrench	1 Set	Plastic Case	0.91



Designed for Electricians

Drill Screw Chuck With Magnetic Insert



CATALOG NUMBER	UPC NUMBER	SIZE	LENGTH	STD PAK [◇] PCS/PKG	PKG STYLE	WEIGHT/PKG (lbs.)
DSC14	78103530101	1/4" Hex	1-5/8	5	Bag	0.20
DSC14L	78103530104	1/4" Hex	2-9/16	5	Bag	0.31
DSC516	78103530102	5/16" Hex	1-5/8	5	Bag	0.23
DSC516L	78103530105	5/16" Hex	2-9/16	5	Bag	0.36
DSC38	78103530103	3/8" Hex	1-5/8	5	Bag	0.27
DSC38L	78103530106	3/8" Hex	2-9/16	5	Bag	0.41

1/4" Hex Shank Phillips Insert & Power Bits



CATALOG NUMBER*	UPC NUMBER	OVERALL LENGTH	POINT SIZE	STD PAK [◇] PCS/PKG	PKG STYLE	WEIGHT/PKG (lbs.)
250-PB1	78103530301	1"	1	5	Bag	0.06
250-PB2	78103530302	1"	2	5	Bag	0.06
250-PB3	78103530303	1"	3	5	Bag	0.06
30-PB1	78103530201	1-15/16"	1	5	Bag	0.12
30-PB2	78103530202	1-15/16"	2	5	Bag	0.12
30-PB3	78103530203	1-15/16"	3	5	Bag	0.13
300-PB1	78103530211	3"	1	5	Bag	0.15
300-PB2	78103530212	3"	2	5	Bag	0.18
300-PB3	78103530213	3"	3	5	Bag	0.18
600-PB1	78103530221	6"	1	5	Bag	0.36
600-PB2	78103530222	6"	2	5	Bag	0.36
600-PB3	78103530223	6"	3	5	Bag	0.38

1/4" Hex Shank Square Drive Insert & Power Bits



CATALOG NUMBER*	UPC NUMBER	OVERALL LENGTH	POINT SIZE	STD PAK [◇] PCS/PKG	PKG STYLE	WEIGHT/PKG (lbs.)
250-SQ1	78103530311	1"	1	5	Bag	0.05
250-SQ2	78103530312	1"	2	5	Bag	0.06
250-SQ3	78103530313	1"	3	5	Bag	0.07
30-SQ1	78103530231	1-15/16"	1	5	Bag	0.11
30-SQ2	78103530232	1-15/16"	2	5	Bag	0.11
30-SQ3	78103530233	1-15/16"	3	5	Bag	0.11

For 1/4" Hex Insert Bits Magnetic Bit Holder With Retaining Ring



CATALOG NUMBER*	UPC NUMBER	OVERALL LENGTH	STD PAK [◇] PCS/PKG	PKG STYLE	WEIGHT/PKG (lbs.)
MBHN14	78103530414	2-7/8"	1	Bag	0.09

[◇] Other quantities per individual package may be available. Contact Selecta for details.

Professional Power Tool Accessories • Bag & Clam Shell

Ideal for Peg Board Counter Area • Most Popular Sizes



CATALOG NUMBER	UPC NUMBER	DESCRIPTION	LENGTH	STD PAK [◇] PCS/PKG	WEIGHT/PKG (lbs.)
BPIIB1	78103530601	#1 Phillips Insert Bit	1	10	0.18
BPIIB2	78103530602	#2 Phillips Insert Bit	1	10	0.19
BPIIB3	78103530603	#3 Phillips Insert Bit	1	10	0.19
BPSQIB2	78103530604	#2 Square Drive Insert Bit	1	10	0.19
BPSIB68	78103530605	6-8 Slotted Insert Bit	1	10	0.19
BPSIB810	78103530606	8-10 Slotted Insert Bit	1	10	0.19
BPSIB1012	78103530607	10-12 Slotted Insert Bit	1	10	0.19
BPPP1	78103530608	#1 Phillips Power Bit	1-15/16	5	0.18
BPPP2	78103530609	#2 Phillips Power Bit	1-15/16	5	0.19
BPSPB810	78103530610	8-10 Slotted Power Bit	1-15/16	5	0.21
BPDEBPB	78103530611	#2 Phillips Dbl Ended Bit	1-3/4	2	0.11
BPDEBPBS	78103530612	#2 Phillips Slotted Dbl End Bit	1-1/2	2	0.18
MAGNETIZED					
BPDSC14-2	78103530613	1/4" Drill Chuck Nut Setter	1-5/8	2	0.15
BPDSC14L-2	78103530614	1/4" Drill Chuck Long Nut Setter	2-9/162	2	0.20
BPDSC516-2	78103530615	5/16" Drill Chuck Nut Setter	1-5/8	2	0.17
BPDSC516L-2	78103530616	5/16" Drill Chuck Long Nut Setter	2-9/16	2	0.22
BPDSC38-2	78103530617	3/8" Drill Chuck Nut Setter	1-7/8	2	0.18
BPDSC38L-2	78103530618	3/8" Drill Chuck Long Nut Setter	2-9/16	2	0.26
BPMBHN14	78103530619	Magnetic Hex Insert Bit Holder	2-7/8	1	0.15



Six-Way Screwdriver

The Convenience of 6 Screwdrivers in 1!

CATALOG NUMBER	UPC NUMBER	DESCRIPTION	STD PAK [◇] PCS/PKG	WEIGHT/PKG (lbs.)
SDSW12	78103530801	Six-Way Screwdriver	12 Per Counter Display	0.66



[◇] Other quantities per individual package may be available. Contact Selecta for details.

Dial-A-Bit The Right Bit Each Time



CATALOG NUMBER	UPC NUMBER	CONTENTS	PKG STYLE	WEIGHT/ PKG (lbs.)
DAB10	78103530110	10 PIECE SET: 1 MAGNETIC BIT HOLDER 1 #1 Phillips Insert Bit 2 #2 Phillips Insert Bit 1 #3 Phillips Insert Bit 1 #6 Slotted Insert Bit 1 #8 Slotted Insert Bit 1 #10 Slotted Insert Bit 1 #2 Square Insert Bit 1 #3 Square Insert Bit	Plastic Case	0.24

- Convenience in a rotating case
- X-Hard industrial bit

Thirty-Bit-Kit



CATALOG NUMBER	UPC NUMBER	INCLUDES:	OVERALL LENGTH	BIT/POINT SIZE	PKG STYLE	WEIGHT/ PKG (lbs.)
TBK30	78103530117	Driver Bit Holder Allen Bits TORX® Bits Square Recess Bit Slotted Bits Phillips Bits POZIDRIV® Bit Socket Adapter Plastic Case	7" 3" 1" 1" 1" 1" 1" 1" 1" 1"	1/4 1/4 5/64; 3/32; 7/64; 1/8; 9/64 T10, T15, T20, T25, T27, T30, T40 #0, #1, #2, #3 3-4, 4-5, 6-8, 8-10 #1, #2, #3 #1, #2, #3	Plastic Case	1.00

NOTE: Item TBK20 Twenty-Bit-Kit (UPC# 78103530115) has been replaced by TBK30 above. Please contact Selecta for details.

"Nail Eating" Ship Auger Bits Hex Shank

CATALOG NUMBER	UPC NUMBER	BORE DIAMETER	OVERALL LENGTH	HEX SHANK	STD PAK [◇] PCS/PKG	PKG STYLE	WEIGHT/PKG (lbs.)
420 SERIES 8" OVERALL LENGTH 6" TWIST LENGTH							
420-12	78103525002	1/2	8"	7/16	1	Plastic Tube	0.24
420-916	78103525003	9/16	8"	7/16	1	Plastic Tube	0.25
420-58	78103525004	5/8	8"	7/16	1	Plastic Tube	0.29
420-1116	78103525005	11/16	8"	7/16	1	Plastic Tube	0.31
420-34	78103525006	3/4	8"	7/16	1	Plastic Tube	0.43
420-1316	78103525007	13/16	8"	7/16	1	Plastic Tube	0.42
420-78	78103525008	7/8	8"	7/16	1	Plastic Tube	0.50
420-1516	78103525009	15/16	8"	7/16	1	Plastic Tube	0.40
420-1	78103525010	1	8"	7/16	1	Plastic Tube	0.45
420-118	78103525011	1-1/8	8"	7/16	1	Plastic Tube	0.92
420-114	78103525012	1-1/4	8"	7/16	1	Plastic Tube	0.93
420-138	78103525013	1-3/8	8"	7/16	1	Plastic Tube	0.82
420-112	78103525014	1-1/2	8"	7/16	1	Plastic Tube	1.22
520 SERIES 18" OVERALL LENGTH 12" TWIST LENGTH							
520-12	78103525019	1/2	18"	7/16	1	Plastic Tube	0.46
520-916	78103525020	9/16	18"	7/16	1	Plastic Tube	0.65
520-58	78103525021	5/8	18"	7/16	1	Plastic Tube	0.72
520-1116	78103525022	11/16	18"	7/16	1	Plastic Tube	0.87
520-34	78103525023	3/4	18"	7/16	1	Plastic Tube	0.71
520-1316	78103525024	13/16	18"	7/16	1	Plastic Tube	1.10
520-78	78103525025	7/8	18"	7/16	1	Plastic Tube	1.24
520-1516	78103525026	15/16	18"	7/16	1	Plastic Tube	1.34
520-1	78103525027	1	18"	7/16	1	Plastic Tube	1.54
520-118	78103525028	1-1/8	18"	7/16	1	Plastic Tube	1.80
520-114	78103525029	1-1/4	18"	7/16	1	Plastic Tube	2.20
520-138	78103525030	1-3/8	18"	7/16	1	Plastic Tube	2.39
520-112	78103525031	1-1/2	18"	7/16	1	Plastic Tube	3.30



Electricians Power Bits Single Spur • Double Twist

CATALOG NUMBER	UPC NUMBER	BORE DIAMETER	OVERALL LENGTH	HEX SHANK	STD PAK [◇] PCS/PKG	PKG STYLE	WEIGHT/PKG (lbs.)
8-1/2" OVERALL LENGTH 5-1/2" TWIST LENGTH							
EPB58	78103526056	5/8"	8-1/2"	5/16	1	Plastic Tube	0.34
EPB1116	78103526051	11/16"	8-1/2"	5/16	1	Plastic Tube	0.40
EPB34	78103526055	3/4"	8-1/2"	5/16	1	Plastic Tube	0.48
EPB1316	78103526054	13/16"	8-1/2"	5/16	1	Plastic Tube	0.55
EPB78	78103526057	7/8"	8-1/2"	5/16	1	Plastic Tube	0.62
EPB1	78103526050	1"	8-1/2"	5/16	1	Plastic Tube	0.69
EPB118	78103526053	1-1/8"	8-1/2"	5/16	1	Plastic Tube	0.75
EPB114	78103526052	1-1/4"	8-1/2"	5/16	1	Plastic Tube	0.90



Ship Auger Extensions

CATALOG NUMBER	UPC NUMBER	HEX SIZE	LENGTH	STD PAK [◇] PCS/PKG	PKG STYLE	WEIGHT/PKG (lbs.)
ABE12	78103525130	7/16	12"	1	Plastic Tube	0.35
ABE18	78103525131	7/16	18"	1	Plastic Tube	1.19



[◇] Other quantities per individual package may be available. Contact Selecta for details.

Spade Point Flat Wood Boring Bits



CATALOG NUMBER	UPC NUMBER	SIZE	LENGTH	STD PAK [◇] PCS/PKG	PKG STYLE	WEIGHT/ PKG (lbs.)
WBB146	78103525050	1/4	6"	1	Plastic Pouch	0.07
WBB5166	78103525051	5/16	6"	1	Plastic Pouch	0.07
WBB386	78103525052	3/8	6"	1	Plastic Pouch	0.09
WBB7166	78103525053	7/16	6"	1	Plastic Pouch	0.09
WBB126	78103525054	1/2	6"	1	Plastic Pouch	0.11
WBB9166	78103525055	9/16	6"	1	Plastic Pouch	0.11
WBB586	78103525066	5/8	6"	1	Plastic Pouch	0.12
WBB11166	78103525056	11/16	6"	1	Plastic Pouch	0.13
WBB346	78103525057	3/4	6"	1	Plastic Pouch	0.11
WBB13166	78103525058	13/16	6"	1	Plastic Pouch	0.11
WBB786	78103525059	7/8	6"	1	Plastic Pouch	0.15
WBB15166	78103525060	15/16	6"	1	Plastic Pouch	0.11
WBB16	78103525061	1	6"	1	Plastic Pouch	0.12
WBB1186	78103525062	1-1/8	6"	1	Plastic Pouch	0.14
WBB1146	78103525063	1-1/4	6"	1	Plastic Pouch	0.15
WBB1386	78103525064	1-3/8	6"	1	Plastic Pouch	0.15
WBB1126	78103525065	1-1/2	6"	1	Plastic Pouch	0.16
WBB1416	78103525070	1/4	16"	1	Plastic Pouch	0.22
WBB51616	78103525071	5/16	16"	1	Plastic Pouch	0.23
WBB3816	78103525072	3/8	16"	1	Plastic Pouch	0.25
WBB71616	78103525073	7/16	16"	1	Plastic Pouch	0.27
WBB1216	78103525074	1/2	16"	1	Plastic Pouch	0.29
WBB91616	78103525075	9/16	16"	1	Plastic Pouch	0.30
WBB5816	78103525076	5/8	16"	1	Plastic Pouch	0.31
WBB111616	78103525077	11/16	16"	1	Plastic Pouch	0.30
WBB3416	78103525078	3/4	16"	1	Plastic Pouch	0.31
WBB131616	78103525079	13/16	16"	1	Plastic Pouch	0.31
WBB7816	78103525086	7/8	16"	1	Plastic Pouch	0.31
WBB151616	78103525080	15/16	16"	1	Plastic Pouch	0.73
WBB116	78103525081	1	16"	1	Plastic Pouch	0.34
WBB11816	78103525082	1-1/8	16"	1	Plastic Pouch	0.34
WBB11416	78103525083	1-1/4	16"	1	Plastic Pouch	0.35
WBB13816	78103525084	1-3/8	16"	1	Plastic Pouch	0.35
WBB11216	78103525085	1-1/2	16"	1	Plastic Pouch	0.36

Extension For Spade Bits



CATALOG NUMBER	UPC NUMBER	OVERALL LENGTH	STD PAK [◇] PCS/PKG	PKG STYLE	WEIGHT/ PKG (lbs.)
SBE12	78103525150	12"	1	Plastic Pouch	0.32

[◇] Other quantities per individual package may be available. Contact Selecta for details.

Carbide Masonry Drill Bits

CATALOG NUMBER	UPC NUMBER	SIZE	LENGTH	SHANK DIAMETER	STD PAK [◇] PCS/PKG	PKG STYLE	WEIGHT/ PKG (lbs.)
* MD3164	78103525103	3/16	4"	3/16"	5	Bag	0.15
* MD144	78103525105	1/4	4"	1/4"	5	Bag	0.18
* MD5164	78103525107	5/16	4"	1/4"	5	Bag	0.25
* MD384	78103525109	3/8	4"	1/4"	5	Bag	0.40
MD124	78103525111	1/2	4"	1/4"	5	Bag	0.55
MD146	78103525112	1/4	6"	1/4"	5	Bag	0.26
MD5166	78103525113	5/16	6"	1/4"	5	Bag	0.40
MD386	78103525114	3/8	6"	3/8"	5	Bag	0.53
MD7166	78103525115	7/16	6"	1/4"	5	Bag	0.75
MD126	78103525116	1/2	6"	3/8"	5	Bag	1.00
MD9166	78103525117	9/16	6"	3/8"	5	Bag	1.55
MD586	78103525118	5/8	6"	3/8"	5	Bag	1.55
MD346	78103525119	3/4	6"	1/2"	5	Bag	2.20
MD786	78103525120	7/8	6"	1/2"	5	Bag	2.90
MD16	78103525121	1	6"	1/2"	5	Bag	3.75
MD142	78103525122	1/4	12"	1/4"	1	Bag	0.17
MD5162	78103525123	5/16	12"	1/4"	1	Bag	0.22
MD382	78103525124	3/8	12"	3/8"	1	Bag	0.33
MD122	78103525125	1/2	12"	3/8"	1	Bag	0.44
MD582	78103525126	5/8	12"	3/8"	1	Bag	0.71
MD342	78103525127	3/4	12"	1/2"	1	Bag	0.91
MD782	78103525128	7/8	12"	1/2"	1	Bag	1.37
MD12	78103525129	1	12"	1/2"	1	Bag	1.66



SDS - Plus - Hammer Drill Bits Special Tungsten Carbide Tip

CATALOG NUMBER	UPC NUMBER	SIZE	LENGTH	USABLE LENGTH	STD PAK [◇] PCS/PKG	PKG STYLE	WEIGHT/ PKG (lbs.)
SDSHB3164	78103525800	3/16	4"	2"	1	Plastic Pouch	0.09
SDSHB144	78103525801	1/4	4"	2"	1	Plastic Pouch	0.10
SDSHB3166	78103525802	3/16	6"	4"	1	Plastic Pouch	0.11
SDSHB146	78103525803	1/4	6"	4"	1	Plastic Pouch	0.12
SDSHB5166	78103525804	5/16	6"	4"	1	Plastic Pouch	0.11
SDSHB386	78103525805	3/8	6"	4"	1	Plastic Pouch	0.17
SDSHB7169	78103525806	7/16	9"	6"	1	Plastic Pouch	0.33
SDSHB126	78103525807	1/2	6"	4"	1	Plastic Pouch	0.22
SDSHB9169	78103525808	9/16	9"	6"	1	Plastic Pouch	0.36
SDSHB588	78103525809	5/8	8"	6"	1	Plastic Pouch	0.32
SDSHB348	78103525810	3/4	8"	6"	1	Plastic Pouch	0.48
SDSHB7810	78103525811	7/8	10"	8"	1	Plastic Pouch	0.56
SDSHB110	78103525812	1	10"	8"	1	Plastic Pouch	0.75
SDSHB3812	78103525813	3/8	12"	10"	1	Plastic Pouch	0.27
SDSHB1212	78103525814	1/2	12"	10"	1	Plastic Pouch	0.41
SDSHB5812	78103525815	5/8	12"	10"	1	Plastic Pouch	0.50
SDSHB3412	78103525816	3/4	12"	10"	1	Plastic Pouch	0.69
SDSHB3818	78103525817	3/8	18"	16"	1	Plastic Pouch	0.38
SDSHB1218	78103525818	1/2	18"	16"	1	Plastic Pouch	0.63
SDSHB5818	78103525819	5/8	18"	16"	1	Plastic Pouch	0.76
SDSHB3418	78103525820	3/4	18"	16"	1	Plastic Pouch	1.08



* Available in plastic pouches. Add "C" to end of the stock number.
[◇] Other quantities per individual package may be available. Contact Selecta for details.

Bi-Metal Hole Saws • Variable Pitch Individually Packed



CATALOG NUMBER	UPC NUMBER	DIAMETER INCHES	DIAMETER MM	STD PAK [◇] PCS/PKG	PKG STYLE	WEIGHT/ PKG (lbs.)
HS916	78103530700	9/16	14	1	Box	0.08
HS58	78103530701	5/8	16	1	Box	0.09
HS1116	78103530702	11/16	17	1	Box	0.09
HS34	78103530703	3/4	19	1	Box	0.09
HS1316	78103530704	13/16	21	1	Box	0.11
HS78	78103530705	7/8	22	1	Box	0.11
HS1516	78103530706	15/16	24	1	Box	0.13
HS1	78103530707	1	25	1	Box	0.14
HS118	78103530708	1-1/8	29	1	Box	0.19
HS1-316	78103530709	1-3/16	30	1	Box	0.20
HS114	78103530710	1-1/4	32	1	Box	0.20
HS1-516	78103530711	1-5/16	33	1	Box	0.21
HS138	78103530712	1-3/8	35	1	Box	0.24
HS112	78103530713	1-1/2	38	1	Box	0.28
HS158	78103530714	1-5/8	41	1	Box	0.34
HS134	78103530715	1-3/4	44	1	Box	0.23
HS178	78103530716	1-7/8	48	1	Box	0.27
HS2	78103530717	2	51	1	Box	0.29
HS218	78103530718	2-1/8	54	1	Box	0.33
HS214	78103530719	2-1/4	57	1	Box	0.36
HS2516	78103530720	2-5/16	59	1	Box	0.33
HS238	78103530721	2-3/8	60	1	Box	0.33
HS212	78103530722	2-1/2	64	1	Box	0.40
HS2916	78103530723	2-9/16	65	1	Box	0.45
HS3	78103530724	3	76	1	Box	0.49
HS312	78103530725	3-1/2	89	1	Box	0.62
HS358	78103530726	3-5/8	92	1	Box	0.66
HS4	78103530727	4	102	1	Box	0.81
HS418	78103530728	4-1/8	105	1	Box	0.85
HS414	78103530729	4-1/4	111	1	Box	0.87
HS412	78103530730	4-1/2	114	1	Box	0.96
HS434	78103530731	4-3/4	121	1	Box	1.03
HS5	78103530732	5	127	1	Box	1.14
HS512	78103530733	5-1/2	140	1	Box	1.30
HS6	78103530734	6	152	1	Box	1.53

Drywall Saw • Individually Packed All Around Utility Saw With 6" Blade



CATALOG NUMBER	UPC NUMBER	DESCRIPTION	STD PAK [◇] PCS/PKG	PKG STYLE	WEIGHT/ PKG (lbs.)
DWS6	78103530850	Wooden Handle, 6" Blade	1	Box	0.28

[◇] Other quantities per individual package may be available. Contact Selecta for details.

Bi-Metal Hole Saw Kits In Plastic Boxes

CATALOG NUMBER	UPC NUMBER	DESCRIPTION OF CONTENTS	STD PAK [◇] PCS/PKG	PKG STYLE	WEIGHT/PKG (lbs.)
HSKE	78103530760	ELECTRICIAN'S HOLE SAW KIT 8 Pc. Set Consisting of: 1 ea. 7/8" - 1-1/8" - 1-3/8" - 1-3/4" 2" - 2-1/2" Bi-Metal Hole Saws 2 Arbors For Above Hole Saws	1 Kit	Plastic Box	2.64
HSKME	78103530761	MASTER ELECTRICIAN'S HOLE SAW KIT 13 Pc. Set Consisting of: 1 ea. 7/8" - 1-1/8" - 1-3/8" - 1-3/4" 2" - 2-1/2" - 3" - 3-5/8" 4-1/8" - 4-1/2" Bi-Metal Hole Saws 3 Arbors For Above Hole Saws	1 Kit	Plastic Box	8.90
HSKP	78103530762	PLUMBER'S HOLE SAW KIT 8 Pc. Set Consisting of: 1 ea. 3/4" - 7/8" - 1-1/8" - 1-1/2" 1-3/4" - 2-1/4" Bi-Metal Hole Saws 2 Arbors For Above Hole Saws	1 Kit	Plastic Box	2.40
HSKM	78103530763	MAINTENANCE HOLE SAW KIT 13 Pc. Set Consisting of: 1 ea. 3/4" - 7/8" - 1-1/8" - 1-3/8" 1-1/2" - 1-3/4" - 2 - 2-1/4" 2-1/2" Bi-Metal Hole Saws 3 Arbors For Above Hole Saws 1 Extension	1 Kit	Plastic Box	4.40



Arbor For Hole Saws

CATALOG NUMBER*	UPC NUMBER	SIZE	SHANK	STD PAK [◇] PCS/PKG	PKG STYLE	WEIGHT/PKG (lbs.)
HSA14R	78103530740	9/16 to 1-3/16	1/4 Round	1	Box	0.13
HSA716H	78103530741	9/16 to 1-3/16	7/16 Hex	1	Box	0.16
HSA38H	78103530742	1-1/4 to 6	3/8 Hex	1	Box	0.36
HSA716HH	78103530743	1-1/4 to 6	7/16 Hex	1	Box	0.50

Extra 1/4" Pilot Drill HSS Bits

CATALOG NUMBER*	UPC NUMBER	SIZE	SHANK	STD PAK [◇] PCS/PKG	PKG STYLE	WEIGHT/PKG (lbs.)
HSPB14F	78103530755	4-1/2"	1/4" - 3 Flats	1	Bag	0.05
HSPB14S	78103530756	4-1/2"	1/4" - 3 Steps	1	Bag	0.05
HSPB14F1	78103581399	4-1/2"	1/4" - 1 Flat	1	Bag	0.05



[◇] Other quantities per individual package may be available. Contact Selecta for details.

Bi-Metal Reciprocating Saw Blades 5-Pack • White Finish



Made in the USA



These Professional Bi-Metal blades fit Milwaukee Sawzall®, Makita, Porter Cable, Black & Decker and other reciprocating saws.

CATALOG NUMBER	UPC NUMBER	DESCRIPTION	# OF TEETH PER INCH	WIDTH/LENGTH	STD PAK [◇] PCS/PKG	PKG STYLE	WEIGHT/ KG (lbs.)
RB636W	78103530820	6" X 6T Wood & Nail Slope	6	3/4" X 6" X .050	5	Plastic Pouch	0.21
RB656WS	78103530821	6" X 6T Wood & Nail Scroll	6	3/4" X 6" X .050	5	Plastic Pouch	0.21
RB956W	78103530822	9" X 6T Wood & Nail	6	3/4" X 9" X .050	5	Plastic Pouch	0.37
RB125W	78103530823	12" X 6T Wood & Nail	6	3/4" X 12" X .050	5	Plastic Pouch	0.53
RB414M	78103530824	4" X 14T Short Metal Cutting	14	5/8" X 4" X .035	5	Plastic Pouch	0.13
RB418M	78103530825	4" X 18T Short Metal Cutting	18	5/8" X 4" X .035	5	Plastic Pouch	0.13
RB424M	78103530826	4" X 24T Thin Short Metal Cut	24	5/8" X 4" X .035	5	Plastic Pouch	0.13
RB610HDM	78103530827	6" X 10T HD Metal Cutting	10	3/4" X 6" X .035	5	Plastic Pouch	0.20
RB614HDM	78103530828	6" X 14T HD Metal Cutting	14	3/4" X 6" X .035	5	Plastic Pouch	0.21
RB618HDM	78103530829	6" X 18T HD Metal Cutting	18	3/4" X 6" X .035	5	Plastic Pouch	0.21
RB624HDM	78103530830	6" X 24T HD Metal Cutting	24	3/4" X 6" X .035	5	Plastic Pouch	0.21
RB810HDM	78103530831	8" X 10T HD Metal Cutting	10	3/4" X 8" X .035	5	Plastic Pouch	0.28
RB814HDM	78103530832	8" X 14T HD Metal Cutting	14	3/4" X 8" X .035	5	Plastic Pouch	0.28
RB1218HDM	78103530833	12" X 18T HD Metal Cutting	18	3/4" X 12" X .035	5	Plastic Pouch	0.52
RB636DW	78103530834	Drywall Cutting w/V Head	12	5/8" X 6" X .035	5	Plastic Pouch	0.21
R8CCRF	78103530835	Cast Iron-Ceramic Tile	Carbide Grit	3/4 X 8" Long	5	Plastic Pouch	0.45

Bi-Metal Hand Hack Saw Blades



Made in the USA



CATALOG NUMBER	UPC NUMBER	BLADE SIZE	TEETH/ INCH	WIDE	THICK	STD PAK [◇] PCS/PKG	PKG STYLE	WEIGHT/ PKG (lbs.)
HSB1218	78103530745	12"	18	1/2"	.025	10	Plastic Pouch	0.43
HSB1224	78103530746	12"	24	1/2"	.025	10	Plastic Pouch	0.43
HSB1232	78103530747	12"	32	1/2"	.025	10	Plastic Pouch	0.43

- Premium quality
- High wear resistance
- High performance
- White finish
- Made in the USA

High Tension Hack Saw Frame



CATALOG NUMBER	UPC NUMBER	STD PAK [◇] PCS/PKG	PKG STYLE	WEIGHT/ PKG (lbs.)
HSF-1	78103530750	10	Bag	1.47

- Cast aluminum
- Extremely rigid
- 25,000 lbs/sq. inch
- Includes one 12 inch x 24 teeth per inch blade

[◇] Other quantities per individual package may be available. Contact Selecta for details.

Caulking Gun

Sturdy, Heavy Gauge Metal • Heavy-Duty Handle & Lever

CATALOG NUMBER	UPC NUMBER	STD PAK [◇] PCS/PKG	PKG STYLE	WEIGHT/PKG (lbs.)
CG101	78103530500	1	Box	1.06



Wood Drills • Saw Tooth Bits • Multi-Spur Bits

Bores Large, Deep Holes Fast

CATALOG NUMBER*	UPC NUMBER	BORE DIAMETER	APPLICATION	STD PAK [◇] PCS/PKG	PKG STYLE	WEIGHT/PKG (lbs.)
WD138	78103530806	1-3/8"	7/8" Pipes	1	Bag	0.43
WD112	78103530807	1-1/2"	1" Pipes	1	Bag	0.46
WD134	78103530808	1-3/4"	1-1/4" Pipes	1	Bag	0.51
WD218	78103530809	2-1/8"	1-1/2" Pipes	1	Bag	0.74
WD2916	78103530810	2-9/16"	2" Pipes	1	Bag	0.89
WD358	78103530811	3-5/8"	3" Pipes	1	Bag	1.85
WD458	78103530812	4-5/8"	4" Pipes	1	Bag	3.50



Packed individually with an extra set of screws and wrench.

The Stopper™

CATALOG NUMBER	UPC NUMBER	STD PAK [◇] PCS/PKG	PKG STYLE	WEIGHT/PKG (lbs.)
STOP1	78103529250	1	Bag	0.03

- Stops damage to drywall
- Sets drywall screws perfectly flush
- Works perfectly every time
- Use in any bit holder
- Use any drill machine, rotation only
- 9/16" collar diameter



The Power Stopper™

CATALOG NUMBER	UPC NUMBER	STD PAK [◇] PCS/PKG	PKG STYLE	WEIGHT/PKG (lbs.)
STOP2	78103529251	1	Bag	0.07

- Prevents overdriving screws into material
- Reduces tip wear
- Magnetic set inside stopper for holding screws
- Set & lock for adjustable depth
- 1/4" drive for use in any machine and any tip
- Tips not included



[◇] Other quantities per individual package may be available. Contact Selecta for details.

Security Screw Selector Chart

The fasteners on this chart are available in a wide range of diameters and lengths, stainless steel and zinc-plated steel. Call for requirement or application. Our staff is ready to serve.

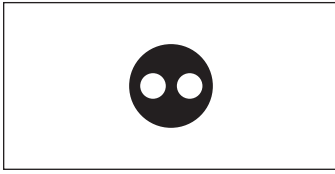

Snake Eyes® Spanners

Machine Screws:

Pan Head
Truss Head
Flat Head
Flat Head (Brass)
Oval Head
Oval Head (Brass)

Sheet Metal Screws:

Truss Head
Pan Head
Flat Head
Oval Head

Nuts:

Spanner Nuts
Nut Bit and Driver



Socket Security

Cap Screws:

Button Head
Flat Head

Sheet Metal Screws:

Button Head

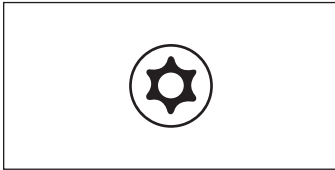

TORX® Security

Machine Screws:

Button Head
Flat Head

Sheet Metal & Self-Drilling Screws:

Button Head
Pan Head
Flat Head

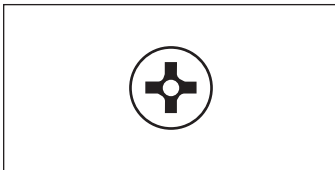

Phillips Security

Machine Screws:

Pan Head
Flat Head

Sheet Metal Screws:

Pan Head
Flat Head

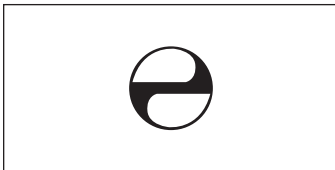

One-Way

Machine Screws:

Round Head
Truss Head
Oval Head
Sex Bolts

Sheet Metal Screws:

Round Head
Oval Head

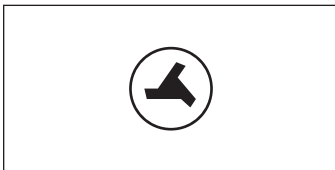

Tri-Wing

Machine Screws:

Pan Head

Sheet Metal Screws:

Pan Head

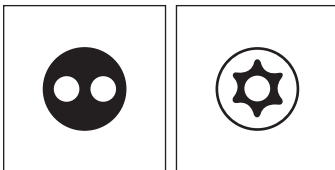

Metric

Snake Eyes® Spanners

Machine Screws:

Pan Head
Oval Head
Flat Head

TORX® Security

Sheet Metal Screws:

Button Head
Pan Head



Tools & Kits

Spanner
Tri-Wing®
Socket Pin Head

Phillips Pin Head
Torx® Security

One-Ways
Complete Tool Kit

Tamper-Resistant Bits

CATALOG NUMBER	UPC NUMBER	SIZE/ DESCRIPTION	STD PAK [®] PCS/PKG	PKG STYLE	WEIGHT/ PKG (lbs.)
SPIB-6	78103530320	#6 Spanner	5	Bag	0.05
SPIB-8	78103530321	#8 Spanner	5	Bag	0.05
SPIB10	78103530322	#10 Spanner	5	Bag	0.05
SPIB-12	78103530324	#12 Spanner	5	Bag	0.05
SPIB-14	78103530325	#14 Spanner	5	Bag	0.05
TSIB-10	78103530330	T10/#6 Screw	5	Bag	0.05
TSIB-15	78103530331	T15/#8 Screw	5	Bag	0.05
TSIB-20	78103530332	T20/#10 Screw	5	Bag	0.05
TSIB-25	78103530333	T25/#10 Screw	5	Bag	0.05
TSIB-27	78103530334	T27/#14 Screw	5	Bag	0.05
TSIB-30	78103530335	T30/#14 Screw	5	Bag	0.05
HSIB-18	78103530340	1/8" Hex	5	Bag	0.05
HSIB-532	78103530341	5/32" Hex	5	Bag	0.05

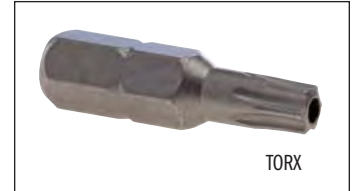

Power Insert Bits
1/4" Hex Shank

Magnetic Hand Driver • Bit Storage in Handle *Bits Not Included*

CATALOG NUMBER	UPC NUMBER	SIZE/ DESCRIPTION	STD PAK [®] PCS/PKG	PKG STYLE	WEIGHT/ KG (lbs.)
MSDH8	78103530150	Magnetic Hand Driver, 1/4" Hex	1	Bag	0.22



One-Way Screw Removal Tool

CATALOG NUMBER	UPC NUMBER	SIZE/ DESCRIPTION	STD PAK [®] PCS/PKG	PKG STYLE	WEIGHT/ PKG (lbs.)
OWRDT-6	78103530162	#6 Screw	1	Bag	0.25
OWRDT-8	78103530163	#8 Screw	1	Bag	0.31
OWRDT-10	78103530164	#10 Screw	1	Bag	0.35
OWRDT-14	78103530165	#14 Screw	1	Bag	0.37



29-Piece Tamper-Resistant Tool Kit

CATALOG NUMBER	UPC NUMBER	SIZE/ DESCRIPTION	STD PAK [®] PCS/PKG	PKG STYLE	WEIGHT/ KG (lbs.)
TPK29	78103530116	29	1	Case	1.03

Kit Includes:

- DRIVER
- TORX[®] Bits
- Hex Pin Bits
- Spanner Bits
- TORO-SET[®] Bits
- TRI-WING[®] Bits
- Square Recess Bits
- POZIDRIVE[®] Bit
- Socket Adaptor
- Bit Holder

Bit/PT Size:

- 1/4" MAGNETIC w/ storage handle
- T9, T10, T15, T20, T25, T27, T30, T40
- 1/8, 9/64, 5/32, 3/16, 7/32, 1/4, 5/16, 3/8
- 6, 8, 1
- 5, 8
- 4, 5
- 1, 2
- 2
- 1/4
- 1/4



Safety Goggles Vinyl



CATALOG NUMBER	UPC NUMBER	DESCRIPTION	STD PAK [◇] PCS/PKG	PKG STYLE	WEIGHT/PKG (lbs.)
SGOG1	78103529050	One Size Fits All	1	Bag	0.18

See our entire selection of Safety Glasses in Section M, on pages M-3 & M-4.

Non-Toxic Dust Masks



CATALOG NUMBER	UPC NUMBER	DESCRIPTION	STD PAK [◇] PCS/PKG	PKG STYLE	WEIGHT/PKG (lbs.)
MSK5SS	78103529100	5 per pack - Single Strap	5	Bag	0.08
MSK50SS	78103529101	50 per box - Single Strap	50	Box	0.68
MSK50DS	78103529102	50 per box - Double Strap	50	Box	0.74

Bungee Cords Poly-Bagged



CATALOG NUMBER	UPC NUMBER	DESCRIPTION	STD PAK [◇] PCS/PKG	PKG STYLE	WEIGHT/PKG (lbs.)
BC-3	78103530875	24" Bungee Cord (3 Pak)	1	Bag	0.45
BC-6	78103530876	Bungee Cord (6) Multi-Pak (1) 30" (1) 24" (2) 18" (2) 10"	1	Bag	0.64

Ratchet Tie-Down



CATALOG NUMBER	UPC NUMBER	DESCRIPTION	STD PAK [◇] PCS/PKG	PKG STYLE	WEIGHT/PKG (lbs.)
RTD-1	78103530880	14" Ratchet Tie-Down Extra Wide and Padded, 1,000 Lb. Load Limit	1	Box	2.60

Bag/Box of Rags



CATALOG NUMBER	UPC NUMBER	DESCRIPTION	PKG STYLE	WEIGHT/PKG (lbs.)
BOR-16	78103530860	1 Lb. Bag of New Colored Knits	Bag	1.05
BOR-25	78103530861	25 Lb. Box of New Colored Knits	Box	25.00
BOR-50	78103530862	50 Lb. Box of New Colored Knits	Box	50.00

Utility Knife & Blades



CATALOG NUMBER	UPC NUMBER	DESCRIPTION	STD PAK [◇] PCS/PKG	PKG STYLE	WEIGHT/PKG (lbs.)
UKRB	78103529200	Utility Knife - Retractable Blade	1/Card	Box	0.30
UKRB5	78103529201	Utility Knife - Replacement Blades	5/Card	Box	0.04
UKRB100	78103529202	Utility Knife - Replacement Blades	100 (20 Packs of 5)	Box	0.92

[◇] Other quantities per individual package may be available. Contact Selecta for details.

CRC[^] Minimal Expansion Foam



Made in the USA

CATALOG NUMBER	UPC NUMBER	DESCRIPTION	STD PAK	PKG STYLE	CASE QTY	WEIGHT/ PKG (lbs.)
14077	661191460560	16 oz. Aerosol Can	1	Can	12	0.83

Polyurethane foam designed to fill, seal, bond, retrofit, insulate and deaden sound in and around cracks and cavities. It forms a permanent, waterproof and airtight bond to masonry, wood, glass, metal & most plastics.

- Stops drafts, dust, moisture, insects and rodents
- When cured, foam can be sanded, painted or stained
- The low expansion formula expands 50% when fully cured
- Cured foam insulates to R-5 for each inch of foam
- UL[®] classified as a caulking sealant
- Foam and propellant are non-flammable
- Convenient 360° valve – can be sprayed from any position
- Reusable for up to 30 days after initial use
- Made in the USA

Additional CRC products are featured in Section S.



Always Wear Safety Glasses & Gloves



CRC Minimal Expansion Foam Specs:

ROOM TEMP. CURING	CORROSIVE TO METALS	TEMPERATURE RANGE	CONFORMS TO SPECIFICATIONS
Yes	No	-200° to 200° F (cured foam)	Insulates to R-5

First Aid Kits • Safety on the Job



Assembled in the USA*

CATALOG NUMBER	UPC NUMBER	DESCRIPTION	STD PAK	PKG STYLE	WEIGHT/ PKG (lbs.)
FA-SMALL	78103530870	100 Pcs. - Ideal for Truck/Auto	1 Case	Plastic Case	0.80
FA-OSHA	78103530871	170 Pcs. - Job Site "OSHA" Kit This Kit meets ANSI & OSHA Guidelines	1 Case	Plastic Case	1.62



Additional safety products are featured Section M.



[^] All products from CRC are available. The products shown in this section are for reference only as being related with fastener products. Contact Selecta for details on other CRC products.

* Assembled in the USA of domestic and imported components. Case made in the USA.

Step Drill Bits HSS • Multi-Cone



CATALOG NUMBER	UPC NUMBER	SIZE	NUMBER OF STEPS	STD PAK PCS/PKG	PKG STYLE	WEIGHT/PKG (lbs.)
MCC18-12	78103530910	1/8, 5/32, 3/16, 7/32, 1/4, 9/32, 5/16, 11/32, 3/8, 13/32, 7/16, 15/32, 1/2	13	1	Bag	0.59
MCC316-12	78103530911	3/16, 1/4, 5/16, 3/8, 7/16, 1/2	6	1	Bag	0.65
MCC14-34	78103530912	1/4, 5/16, 3/8, 7/16, 1/2, 9/16, 5/8, 11/16, 3/4	9	1	Bag	0.11
MCC316-78	78103530913	3/16, 1/4, 5/16, 3/8, 7/16, 1/2, 9/16, 5/8, 11/16, 3/4, 13/16, 7/8	12	1	Bag	0.15
MCC716-118	78103530914	7/16, 1/2, 9/16, 5/8, 11/16, 3/4, 13/16, 7/8, 15/16, 1, 1-1/16, 1-1/8	12	1	Bag	0.25
MCC34-138	78103530915	3/4, 13/16, 7/8, 15/16, 1, 1-1/16, 1-1/8, 1-3/16, 1-1/4, 1-5/16, 1-3/8	11	1	Bag	0.42
MCC38-34	78103530916	3/8, 7/16, 3/4	3	1	Bag	0.12
MCC78-118	78103530917	7/8, 1-1/8	2	1	Bag	0.17
MCC78-138	78103530918	7/8, 1-1/8, 1-7/32, 1-1/4, 1-3/8	5	1	Bag	0.36

- Lobed non-slip shank
- High speed steel
- Drill up to 1/8" thick material
- Two Flutes

Suitable For:

- Ferrous & non-ferrous sheet metal
- Wood
- Plastic laminates
- Sink grade stainless steel
- Maintenance
- Electrical contracting
- Plumbing
- Auto body repair
- Heating
- Air conditioning
- Rust proofing

Recommended Cutting Speeds

1/8" - 3/8"	1200 RPM
3/8" - 1/2"	600 RPM
1/2" - 5/8"	400 RPM
5/8" - 3/4"	350 RPM
3/4" - 7/8"	300 RPM
1"	260 RPM
1-1/8"	240 RPM
1-1/2"	200 RPM

Work Gloves

Work Gloves come in wide variety of styles. Styles and Fabrics include Cotton, Canvas, Jersey (lined and unlined), PVC Coated, Cowhide, Deerskin and Pigskin.

SP-GL100, 105, 110 & 115 Series

CATALOG NUMBER	UPC NUMBER	SIZE	DESCRIPTION	STD PAK PCS/PKG	PKG STYLE	CASE QTY	WEIGHT/PKG (lbs.)
SP-GL100	78103581191	Fits All	Brown Jersey 9 oz. Cotton	Pair	Bag	1	0.09
SP-GL100-J	78103581193	Jumbo	Brown Jersey 9 oz. Cotton, Size Jumbo	Pair	Bag	1	0.10
SP-GL105	78103581193	Fits All	Dotted Brown Jersey, 8 oz. Cotton Canvas, Wing Thumb Knit Wrist, One Side Dotted	Pair	Bag	1	0.17
SP-GL110	78103581194	Fits All	Inner Red Lined Brown Jersey, 10 oz. Cotton Clute Cut	Pair	Bag	1	0.10
SP-GL115	78103581195	Fits All	Grey String Knit 550 Gram Cotton/Poly Shell - Used as Inner Liner	Pair	Bag	1	0.09



SP-GL120 Series

CATALOG NUMBER	UPC NUMBER	SIZE	DESCRIPTION	STD PAK PCS/PKG	PKG STYLE	CASE QTY	WEIGHT/PKG (lbs.)
SP-GL120-M	78103581196	Medium	Black Disposable Nitrile - Powder Free	50	Box	10 Boxes	0.74
SP-GL120-L	78103581197	Large	Black Disposable Nitrile - Powder Free	50	Box	10 Boxes	0.77
SP-GL120-XL	78103581198	Extra Large	Black Disposable Nitrile - Powder Free	50	Box	10 Boxes	0.78

SP-GL120 Series gloves feature textured fingers, rolled cuff, powder free, 5 mil disposable nitrile, black color. Meets FDA requirements. Industrial Grade.



SP-GL125 Series

CATALOG NUMBER	UPC NUMBER	SIZE	DESCRIPTION	STD PAK PCS/PKG	PKG STYLE	CASE QTY	WEIGHT/PKG (lbs.)
SP-GL125-S	78103581199	Small	Gauntlet Cuff, Split Leather Palm	Pair	Bag	1	0.60
SP-GL125-L	78103581200	Large	Gauntlet Cuff, Split Leather Palm	Pair	Bag	1	0.61
SP-GL125-XL	78103581201	Extra Large	Gauntlet Cuff, Split Leather Palm	Pair	Bag	1	0.62

SP-GL125 Series have a gauntlet cuff, split leather palm, knuckle strap, and extra heavy inner lining for better heat handling.



SP-GL130 Series

CATALOG NUMBER	UPC NUMBER	SIZE	DESCRIPTION	STD PAK PCS/PKG	PKG STYLE	CASE QTY	WEIGHT/PKG (lbs.)
SP-GL130-M	78103581202	Medium	Gauntlet Cuff, Cow Grain Leather Palm	Pair	Bag	1	0.40
SP-GL130-L	78103581203	Large	Gauntlet Cuff, Cow Grain Leather Palm	Pair	Bag	1	0.47
SP-GL130-XL	78103581204	Extra Large	Gauntlet Cuff, Cow Grain Leather Palm	Pair	Bag	1	0.55

SP-GL130 Series have a rubberized gauntlet cuff, better grade cow grain leather palm.



Work Gloves SP-GL135 Series



CATALOG NUMBER	UPC NUMBER	SIZE	DESCRIPTION	STD PAK PCS/PKG	PKG STYLE	CASE QTY	WEIGHT/PKG (lbs.)
SP-GL135-M	78103581205	Medium	Premium Deerskin Driver, Keystone Thumb	Pair	Bag	1	0.29
SP-GL135-L	78103581206	Large	Premium Deerskin Driver, Keystone Thumb	Pair	Bag	1	0.31
SP-GL135-XL	78103581207	Extra Large	Premium Deerskin Driver, Keystone Thumb	Pair	Bag	1	0.33

SP-GL135 Driver Style Gloves are made of premium deerskin, with keystone thumb. Slip-on cuff.

SP-GL140 Series



CATALOG NUMBER	UPC NUMBER	SIZE	DESCRIPTION	STD PAK PCS/PKG	PKG STYLE	CASE QTY	WEIGHT/PKG (lbs.)
SP-GL140-M	78103581208	Medium	Deerskin Split Back Inner Red Lined	Pair	Bag	1	0.30
SP-GL140-L	78103581209	Large	Deerskin Split Back Inner Red Lined	Pair	Bag	1	0.31
SP-GL140-XL	78103581210	Extra Large	Deerskin Split Back Inner Red Lined	Pair	Bag	1	0.31

SP-GL140 Driver Style Gloves feature premium grade deerskin grain palm and split leather back. Soft and great feeling with red fleece lining, keystone thumb, slip-on cuff.

SP-GL145 Gripster® Sport Plus Series



CATALOG NUMBER	UPC NUMBER	SIZE	DESCRIPTION	STD PAK PCS/PKG	PKG STYLE	CASE QTY	WEIGHT/PKG (lbs.)
SP-GL145-M	78103581211	Medium	Gripster® Sport, Blue Spandex Backing	Pair	Bag	1	0.32
SP-GL145-L	78103581212	Large	Gripster® Sport, Blue Spandex Backing	Pair	Bag	1	0.34
SP-GL145-XL	78103581213	Extra Large	Gripster® Sport, Blue Spandex Backing	Pair	Bag	1	0.35

SP-GL145 Gripster® Sport Plus gloves are made of blue spandex backing with AireFlex™ palm and finger tips. AireFlex™ washes easily, is durable and flexible. Tacky soft PU sewn in the critical palm area and thumb crotch. It provides protection, allowing dexterity and grip and flexibility. Special PVC reinforcement in all grip and wear areas allow for better grip and wear than standard type. Velcro closure.

SP-GL150 Gripster® Plus Sport Cut Series



CATALOG NUMBER	UPC NUMBER	SIZE	DESCRIPTION	STD PAK PCS/PKG	PKG STYLE	CASE QTY	WEIGHT/PKG (lbs.)
SP-GL150-M	78103581214	Medium	Gripster® Plus Sport, Hi-Vis Orange Backing	Pair	Bag	1	0.37
SP-GL150-L	78103581215	Large	Gripster® Plus Sport, Hi-Vis Orange Backing	Pair	Bag	1	0.38
SP-GL150-XL	78103581216	Extra Large	Gripster® Plus Sport, Hi-Vis Orange Backing	Pair	Bag	1	0.40

SP-GL150 Gripster® Plus Sport Cut. Aralene™ – lined mechanic style. Meets ASTM 1790-05, Level 4, 1662 grams, protection. Orange back color with 3M® Scotchlite reflective material. PU grip material. Velcro closure. Abrasion Resistant Armotex® reinforced thumb crotch. Excellent tactile dexterity and cut protection. Excellent for handling sharp materials such as glass, sheet metal or razor sharp steel.

SP-GL155 Vise Gripster® Extrication Series



CATALOG NUMBER	UPC NUMBER	SIZE	DESCRIPTION	STD PAK PCS/PKG	PKG STYLE	CASE QTY	WEIGHT/PKG (lbs.)
SP-GL155-M	78103581217	Medium	Vise Gripster® Extrication, Abrasion Resistant	Pair	Bag	1	0.38
SP-GL155-L	78103581218	Large	Vise Gripster® Extrication, Abrasion Resistant	Pair	Bag	1	0.40
SP-GL155-XL	78103581219	Extra Large	Vise Gripster® Extrication, Abrasion Resistant	Pair	Bag	1	0.40

SP-GL155 Vise Gripster® Extrication glove. Abrasion resistant Armotex® reinforcement zones over Clarino® synthetic leather on fingers, thumb. Palm reinforced in stress areas. Reinforced patches. EVA-padded knuckle with reflective nylon. Special design debris-control elastic cuff. Sewn with Kevlar thread.

Work Gloves

SP-GL160 Ice Gripster® Series

CATALOG NUMBER	UPC NUMBER	SIZE	DESCRIPTION	STD PAK PCS/PKG	PKG STYLE	CASE QTY	WEIGHT/PKG (lbs.)
SP-GL160-M	78103581220	Medium	Ice Gripster® Rubber on Acrylic Shell - Grey	Pair	Bag	1	0.22
SP-GL160-L	78103581221	Large	Ice Gripster® Rubber on Acrylic Shell - Grey	Pair	Bag	1	0.23
SP-GL160-XL	78103581222	Extra Large	Ice Gripster® Rubber on Acrylic Shell - Grey	Pair	Bag	1	0.24

SP-GL160 Ice Gripster® Series is great for cold weather. Innovative heavy, brushed 10 gauge soft acrylic liner insulates against the cold and the rubber coating gives great grip and helps keep hands dry from the wet and cold. Etched rubber offers outstanding abrasion and puncture resistance.



SP-GL170 Ice Gripster® Series

CATALOG NUMBER	UPC NUMBER	SIZE	DESCRIPTION	STD PAK PCS/PKG	PKG STYLE	CASE QTY	WEIGHT/PKG (lbs.)
SP-GL170-M	78103581223	Medium	Ice Gripster® Rubber on Cloth - Hi-Vis Orange	Pair	Bag	1	0.28
SP-GL170-L	78103581224	Large	Ice Gripster® Rubber on Cloth - Hi-Vis Orange	Pair	Bag	1	0.33
SP-GL170-XL	78103581225	Extra Large	Ice Gripster® Rubber on Cloth - Hi-Vis Orange	Pair	Bag	1	0.38

SP-GL170 Ice Gripster® Series has two layer seamless brushed synthetic terrycloth inner liner provides warmth and comfort in cold conditions. Etched rubber finish gives outstanding grip and stays flexible in cold and harsh environments. Hi Vis orange outer shell.



SP-GL175 Tsunami Grip Tuff™ Hybrid Series

CATALOG NUMBER	UPC NUMBER	SIZE	DESCRIPTION	STD PAK PCS/PKG	PKG STYLE	CASE QTY	WEIGHT/PKG (lbs.)
SP-GL175-M	78103581226	Medium	Tsunami Grip Tuff™ Hybrid, Cut-Resistant Fiber	Pair	Bag	1	0.09
SP-GL175-L	78103581227	Large	Tsunami Grip Tuff™ Hybrid, Cut-Resistant Fiber	Pair	Bag	1	0.11
SP-GL175-XL	78103581228	Extra Large	Tsunami Grip Tuff™ Hybrid, Cut-Resistant Fiber	Pair	Bag	1	0.12

SP-GL175 Tsunami Grip Tuff™ Hybrid is a seamless knit glove that represents the latest development in high performance, cut-resistant fiber technology. The superior cut protection comes from an engineered yarn using a proprietary wrapping process. Liner is made of Aralene™, an aramid fiber with space age strength enhancement, and fiberglass, combined to give a European EN 388, Level 5 cut resistance. High dexterity, 13-gauge glove, with 1525 grams on American ASTM F-1790 for American Level 4 protection. This glove also uses a proprietary two step nitrile that gives grip similar to foam/air injected nitrile but will not saturate through the coating.



Work Gloves & Shoe Covers

SP-GL180 Samurai™ Series



CATALOG NUMBER	UPC NUMBER	SIZE	DESCRIPTION	STD PAK PCS/PKG	PKG STYLE	CASE QTY	WEIGHT/PKG (lbs.)
SP-GL180-M	78103581229	Medium	Samurai™ Seamless Knit, Cut-Resistant Fiber	Pair	Bag	1	0.19
SP-GL180-L	78103581230	Large	Samurai™ Seamless Knit, Cut-Resistant Fiber	Pair	Bag	1	0.20
SP-GL180-XL	78103581231	Extra Large	Samurai™ Seamless Knit, Cut-Resistant Fiber	Pair	Bag	1	0.21

SP-GL180 The Samurai™ is a medium-weight, 10-gauge seamless knit glove that represents the latest development in high performance, cut-resistant fiber technology. Samurai offers superior cut protection with a special patented wrapping process using Spectra® space age fibers. It is classified as SpectraGuard and has the highest level of protection, American ASTM F-1790 Level 4 / EN388 CE Level 5. The Samurai™ also features AlphaSan® antimicrobial protection that lasts the life of the glove. AlphaSan® helps prevent and reduce bacterial growth on the surfaces of the glove. Machine washable, bleachable.

SP-GL185 Series



CATALOG NUMBER	UPC NUMBER	SIZE	DESCRIPTION	STD PAK PCS/PKG	PKG STYLE	CASE QTY	WEIGHT/PKG (lbs.)
SP-GL185-M	78103581232	Medium	Pigskin Driver, Safety Cuff - Hi-Vis Yellow	Pair	Bag	1	0.25
SP-GL185-L	78103581233	Large	Pigskin Driver, Safety Cuff - Hi-Vis Yellow	Pair	Bag	1	0.26
SP-GL185-XL	78103581234	Extra Large	Pigskin Driver, Safety Cuff - Hi-Vis Yellow	Pair	Bag	1	0.27

SP-GL185 This driver has a Hi-Vis yellow back with silver 3M® reflective tape. Made of premium grain pigskin, wing thumb, gunn cut, solid back safety cuff.

CPE Blue Shoe Covers (Chlorinated Polyethylene)



CATALOG NUMBER	UPC NUMBER	SIZE	DESCRIPTION	STD PAK PCS/PKG	PKG STYLE	CASE QTY	WEIGHT/PKG (lbs.)
SP-BSC-L	78103581235	Large	CPE Blue Shoe Covers (Chlorinated Polyethylene)	50	Bag	3 Bags	0.29
SP-BSC-XL	78103581236	X-Large	CPE Blue Shoe Covers (Chlorinated Polyethylene)	50	Bag	3 Bags	0.30

Used for new construction, food processing plants, general sanitary uses.

Qualities:

- Ambidextrous
- Component material comply with FDA requirements
- Food grade

Safety Helmets Serpent® Safety Helmets

Serpent® safety helmets are available in two versions: an unvented Class E version and a vented Class C option. Serpent protects against the most threatening of hazards, and has been independently tested to meet and exceed the ANSI Z89.1 standard to prove it.

Product Features

- Sleek, snake-head-like shell design provides attractive style while offering durable protection
- High-density polyethylene is incredibly light – just 13.1 oz.
- Eight-point, six-strap nylon suspension is comfortable and provides exceptional impact absorption
- Soft, cushioned brow pad helps absorb moisture
- Available with a rotating ratchet suspension, which adjusts to fit head sizes from 6-5/8 – 8-1/4
- Independently tested to meet the voluntary ANSI Z89.1-2009 standards for high visibility (hi-viz shell colors only), lower temperature, and reverse donning

**Other colors, styles and accessories are available.
Contact Selecta for details, minimum order; lead time and pricing.**

Serpent® Class E Unvented Safety Helmet

CATALOG NUMBER	UPC NUMBER	COLOR	HELMET STYLE	ADJUSTMENT TYPE	STD PAK PCS/PKG	CASE QTY	WEIGHT/PKG
SP-HHUVR-WHT	78103581565	White	Serpent®	Ratchet	Each	10	13.10 oz.
SP-HHUVR-YLW	78103581566	Yellow	Serpent®	Ratchet	Each	10	13.10 oz.
SP-HHUVR-PNK	78103581567	Pink	Serpent®	Ratchet	Each	10	13.10 oz.
SP-HHUVR-BLU	78103581645	Blue	Serpent®	Ratchet	Each	10	13.10 oz.

Serpent® is an ultra-comfortable, unvented safety helmet that offers excellent impact resistance and electrical insulation.

- Provides exceptional electrical insulation for a wide range of environments.
- Independently tested to meet and exceed the ANSI Z89.1 Standard for Type 1 Helmets, Class E, G & C

Serpent® Class C Vented Safety Helmet

CATALOG NUMBER	UPC NUMBER	COLOR	HELMET STYLE	ADJUSTMENT TYPE	STD PAK PCS/PKG	CASE QTY	WEIGHT/PKG
SP-HHVR-WHT	78103581286	White	Serpent®	Ratchet	Each	10	13.10 oz.
SP-HHVR-YLW	78103581287	Yellow	Serpent®	Ratchet	Each	10	13.10 oz.
SP-HHVR-PNK	78103581288	Pink	Serpent®	Ratchet	Each	10	13.10 oz.
SP-HHVR-BLU	78103581646	Blue	Serpent®	Ratchet	Each	10	13.10 oz.

Serpent® is an ultra-comfortable, vented hard hat that keeps workers cooler on the jobsite.

- Vented shell allows heat to escape, keeping workers cooler on the jobsite
- Independently tested to meet and exceed the ANSI Z89.1 Standard for Type 1 Helmets, Class C Only



Safety Vests & First Aid Kits

SP-SV1 Series Safety Vest



CATALOG NUMBER	UPC NUMBER	SIZE	DESCRIPTION	STD PAK PCS/PKG	PKG STYLE	CASE QTY	WEIGHT/PKG (lbs.)
SP-SV1-M	78103581237	Medium	Class 2 Orange Safety Vest	Each	Bag	1	0.51
SP-SV1-L	78103581238	Large	Class 2 Orange Safety Vest	Each	Bag	1	0.53
SP-SV1-XL	78103581239	Extra Large	Class 2 Orange Safety Vest	Each	Bag	1	0.55

SP-SV1 Series: Class 2 Orange Safety Vest, Yellow Reflective striping. Surveyor's style vest with four front pockets, upper pockets have dividers for pens/pencils, lower pockets with Velcro® closures. High visibility fluorescent orange, solid front, with lightweight mesh polyester back. 3M™ #2915 reflective fabric on contrasting lime stripe. Zipper front.

SP-SV5 Series Safety Vest



CATALOG NUMBER	UPC NUMBER	SIZE	DESCRIPTION	STD PAK PCS/PKG	PKG STYLE	CASE QTY	WEIGHT/PKG (lbs.)
SP-SV5-M	78103581240	Medium	Class 2 Lime Mesh Safety Vest	Each	Bag	1	0.56
SP-SV5-L	78103581241	Large	Class 2 Lime Mesh Safety Vest	Each	Bag	1	0.57
SP-SV5-XL	78103581242	Extra Large	Class 2 Lime Mesh Safety Vest	Each	Bag	1	0.59

SP-SV5 Series: Class 2 Safety Vest, Lime Mesh, Surveyors type, 3M® Reflective Fabric 8903 over contrasting orange stripe. Mesh with partial solid front. Tab/radio/mic holder each shoulder, safety harness/ back D ring pass through opening on back. Phone/radio hold down velcro closure flap. Four front pockets and one inside pocket. Zipper front.

First Aid Kits • Safety on the Job



Assembled in the USA*



CATALOG NUMBER	UPC NUMBER	DESCRIPTION	STD PAK	PKG STYLE	WEIGHT/PKG (lbs.)
FA-SMALL	78103530870	100 Pcs. - Ideal for Truck/Auto	1 Case	Plastic Case	0.80
FA-OSHA	78103530871	170 Pcs. - Job Site "OSHA" Kit	1 Case	Plastic Case	1.62

This Kit meets ANSI & OSHA Guidelines



* Assembled in the USA of domestic and imported components. Case made in the USA.

Safety Glasses StarLite® Series

CATALOG NUMBER	UPC NUMBER	STYLE	LENS COLOR	FRAME COLOR	STD PAK PCS/PKG	PKG STYLE	CASE QTY	WEIGHT/PKG (lbs.)
SG-4680	78103581306	StarLite®	Clear	Clear	Each	Bag	10	0.06
SG-4683	78103581307	StarLite®	Gray	Gray	Each	Bag	10	0.06

The original, industry-leading design in safety eyewear, combining low-cost protective eyewear with all-around impact protection.

- Incredibly lightweight, weighing less than one ounce
- Deep, universal-fit temples provide side protection equal to that of large side shields
- Independently tested to the ballistics impact section of the U.S. Military standard, MIL-PRF-31013, Clause 3.5.1.1
- 99.99% UV-A, UV-B & UV-C Protection

Independently tested and certified by Underwriters Laboratories to meet ANSI Z87.1+ and CSA Z94.3 standards.



SG-4680



SG-4683

StarLite® SQUARED Series

CATALOG NUMBER	UPC NUMBER	STYLE	LENS COLOR	FRAME COLOR	STD PAK PCS/PKG	PKG STYLE	CASE QTY	WEIGHT/PKG (lbs.)
SG-4480	78103581308	StarLite® SQUARED	Clear	Clear	Each	Bag	10	0.06
SG-4483	78103581309	StarLite® SQUARED	Gray	Gray	Each	Bag	10	0.06

It's hip to be squared – StarLite® SQUARED is the next generation in stylish safety eyewear.

- Contemporary, squared lens design
- Incredibly light, all-around impact protection
- Soft, flexible nosepiece and rubber temples provide extra comfort
- 99.99% UV-A, UV-B & UV-C Protection

Independently tested and certified by Underwriters Laboratories to meet ANSI Z87.1+ and CSA Z94.3 standards.



SG-4480



SG-4483

Conqueror® Series

CATALOG NUMBER	UPC NUMBER	STYLE	LENS COLOR	FRAME COLOR	STD PAK PCS/PKG	PKG STYLE	CASE QTY	WEIGHT/PKG (lbs.)
SG-28GB80	78103581310	Conqueror®	Clear	Black	Each	Bag	10	0.08
SG-28GB83	78103581311	Conqueror®	Gray	Black	Each	Bag	10	0.08
SG-28CM5M	78103581312	Conqueror®	Bronze Mirror	Camo	Each	Bag	10	0.08

With a commanding presence and a keen sense of style, Conqueror® helps to vanquish impact hazards.

- A soft, rubber nosepiece and ergonomic, contoured temple tips for all-day wearability
- Available in a unique "Camo" patterned or glossy black frame
- Adjustable length eyewear retainer with each pair
- 99.99% UV-A, UV-B & UV-C Protection

Independently certified by Underwriters Laboratories to meet ANSI Z87.1+ and CSA Z94.3 standards.



SG-28GB80



SG-28GB83



SG-28CM5M

Swap® Series

CATALOG NUMBER	UPC NUMBER	STYLE	LENS COLOR	FRAME COLOR	STD PAK PCS/PKG	PKG STYLE	CASE QTY	WEIGHT/PKG (lbs.)
SG-21GB79	78103581313	Swap® Anti-Fog	Clear	Black	Each	Bag	10	0.11
SG-21GB78	78103581314	Swap® Anti-Fog	Gray	Black	Each	Bag	10	0.11



SG-21GB79



SG-21GB78

Glasses to goggles in just a snap...change your safety eyewear to meet your needs.

- Temples and head strap included, which can be switched out with the simple push of a button
- Foam-lined frame helps block dust and debris, with venting channels to minimize fogging
- Adjustable head strap for custom fit
- 99.99% UV-A, UV-B & UV-C Protection

Independently certified by Underwriters Laboratories to meet the ANSI Z87.1+ high impact standard.

Wheelz® Series

CATALOG NUMBER	UPC NUMBER	STYLE	LENS COLOR	FRAME COLOR	STD PAK PCS/PKG	PKG STYLE	CASE QTY	WEIGHT/PKG (lbs.)
SG-45079	78103581315	Wheelz® Anti-Fog	Clear	Clear	Each	Bag	10	0.12



SG-45079

Contemporary goggle protection for those who like to work hard, Wheelz® is lightweight and stylish.

- Compact frame is more comfortable than traditional bulky goggles
- Whirlwind ventilation system minimizes fogging by circulating air through the optical chamber
- Elastic head strap can easily be adjusted to ensure a safe, snug fit
- 99.99% UV-A, UV-B & UV-C Protection

Independently tested and certified by Underwriters Laboratories to meet ANSI Z87.1+ and CSA Z94.3 standards.

Vinyl Goggles

CATALOG NUMBER	UPC NUMBER	DESCRIPTION	STD PAK PCS/PKG	PKG STYLE	WEIGHT/PKG (lbs.)
SGOG1	78103529050	One Size Fits All	1	Bag	0.18



SGOG1

Tapes

Vinyl Electrical Tape (Assorted Colors)

Black • Blue • Brown • Green • Gray • Orange • Red • White • Yellow • Purple

CATALOG NUMBER	UPC NUMBER	SIZE	COLOR	STD PAK PCS/PKG	PKG STYLE	CASE QTY	WEIGHT/PKG (lbs.)
SP-ET-BLK	78103581245	3/4" x 66 Ft	Black	10	Sleeve*	100	2.22
SP-ET-BLU	78103581246	3/4" x 66 Ft	Blue	10	Sleeve*	100	2.22
SP-ET-BRN	78103581247	3/4" x 66 Ft	Brown	10	Sleeve*	100	2.22
SP-ET-GRN	78103581248	3/4" x 66 Ft	Green	10	Sleeve*	100	2.22
SP-ET-GRY	78103581249	3/4" x 66 Ft	Gray	10	Sleeve*	100	2.22
SP-ET-ORG	78103581250	3/4" x 66 Ft	Orange	10	Sleeve*	100	2.22
SP-ET-RED	78103581251	3/4" x 66 Ft	Red	10	Sleeve*	100	2.22
SP-ET-WHT	78103581252	3/4" x 66 Ft	White	10	Sleeve*	100	2.22
SP-ET-YLW	78103581253	3/4" x 66 Ft	Yellow	10	Sleeve*	100	2.22
SP-ET-PRL	78103581254	3/4" x 66 Ft	Purple	10	Sleeve*	100	2.22

Our all weather vinyl electrical tapes are excellent for both indoor and outdoor applications. They offer flexibility and pliability to adhere and conform to most irregular surfaces. These UL approved tapes are highly resistant to sun, water, oil, acids, alkalies, corrosive chemicals and aging.

Specifications

- Typical Applications: General splicing, harness wrapping, weather-proofing inside and outdoor connections and receptacles and color coding for quick and easy identification
- Thickness: 7 Mil/0.18mm

Physical Properties

- Elongation: 200%
- Tensile Strength: 26N/cm
- Peel Adhesion (N/cm): 1.8N/cm
- Voltage Breakdown: 8kv
- Flame Retardance: Flame Retardant
- Temperature Resistance (°C): -10°C to +80°C
- Shelf Life (months) 12 Months

Construction

- Backing: Plasticized PVC
- Adhesive: Rubber Based Adhesive
- Certifications: CE, CSA, UL

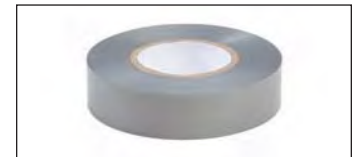
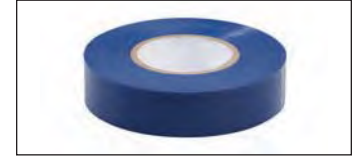

* Vinyl electrical tapes are packaged in cellophane sleeves.

Tapes

Duct Tape

Silver • Red • Black • Yellow • Blue • Green

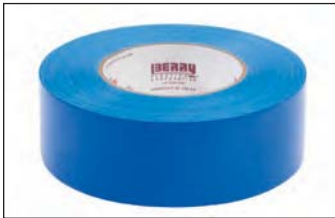
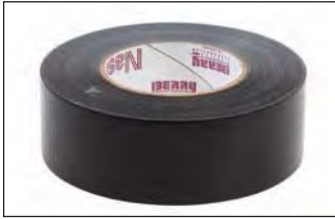

CATALOG NUMBER	UPC NUMBER	SIZE	COLOR	THICKNESS	STD PAK PCS/PKG	PKG STYLE	CASE QTY	WEIGHT/PKG (lbs.)
SP-DT-SLV	78103581255	2" x 60 Yards	Silver	8.5 Mil	1	Bag	24	0.72
SP-DT-RED	78103581256	2" x 60 Yards	Red	8.5 Mil	1	Bag	24	0.72
SP-DT-BLK	78103581257	2" x 60 Yards	Black	8.5 Mil	1	Bag	24	0.72
SP-DT-YLW	78103581258	2" x 60 Yards	Yellow	8.5 Mil	1	Bag	24	0.72
SP-DT-BLU	78103581259	2" x 60 Yards	Blue	8.5 Mil	1	Bag	24	0.72
SP-DT-GRN	78103581260	2" x 60 Yards	Green	8.5 Mil	1	Bag	24	0.72

The SP-DT Series is Versatile PE-coated cloth tape that conforms well to irregular surfaces and adheres to a wide variety of substrates. Tape tears and unwinds easily. Can be used in the home and for general repair, such as, bundling, patching and mending. Also contributes toward satisfying EQ credit 4.1 (Low Emitting Materials and Adhesives & Sealants) under LEED®.

Construction

- Construction: Single Coated
- Backing: Polyethylene Coated Cloth
- Adhesive: Rubber
- Colors: Silver, Red, Black, Yellow, Blue and Green

Physical Properties

- Test Value (Metric) Method
- Total Thickness: 8.5 mils 215.90 μ ASTM D 1000
- Adhesion to Steel: 40 oz/in 4.38 N/cm PSTC-1
- Adhesion to Backing: 35 oz/in 3.83 N/cm PSTC-1
- Tensile Strength: 19 lb/in 33.27 N/cm ASTM D 1000
- Track (Rolling ball): 1.25"
- Maximum Performance
- Temperature: 200 F
- VOC Content: <1 g/L
- Recommended Storage: 40 to 60% Humidity, 60°F to 80°F



Barricade Tape

CATALOG NUMBER	UPC NUMBER	COLOR	LEGEND	MIL THICKNESS	SIZE	STD PAK PCS/PKG*	CASE QTY	WEIGHT/ PKG (lbs.)
3" x 1,000 FT.								
SP-BT100	78103581269	Yellow	Caution Caution Caution	3 Mil	3" x 1000 Ft	1 Roll	12	3.75
SP-BT105	78103581270	Yellow	Caution Do Not Enter	3 Mil	3" x 1000 Ft	1 Roll	12	3.75
SP-BT110	78103581271	Yellow	Caution High Voltage	3 Mil	3" x 1000 Ft	1 Roll	12	3.75
SP-BT115	78103581272	Yellow	Caution Keep Out	3 Mil	3" x 1000 Ft	1 Roll	12	3.75
SP-BT120	78103581273	Yellow	Caution Open Trench	3 Mil	3" x 1000 Ft	1 Roll	12	3.75
SP-BT125	78103581274	Red	Danger Danger Danger	3 Mil	3" x 1000 Ft	1 Roll	12	3.75
SP-BT130	78103581275	Red	Danger Keep Out	3 Mil	3" x 1000 Ft	1 Roll	12	3.75
SP-BT135	78103581276	Black & Yellow	Alternating Stripes	3 Mil	3" x 1000 Ft	1 Roll	12	3.75
SP-BT140	78103581277	Red & White	Alternating Stripes	3 Mil	3" x 1000 Ft	1 Roll	12	3.75
3" x 300 FT.								
SP-BT200	78103581278	Yellow	Caution Caution Caution	3 Mil	3" x 300 Ft	1 Roll	12	3.75
SP-BT205	78103581279	Yellow	Caution Do Not Enter	3 Mil	3" x 300 Ft	1 Roll	12	3.75
SP-BT210	78103581280	Yellow	Caution Keep Out	3 Mil	3" x 300 Ft	1 Roll	12	3.75

Prevent accidents by increasing visibility of hazards with our non-adhesive Barricade Tape. Tape is a lightweight, economical, reusable polyethylene, with a continuous repeat of message or warning. Can be tied, stapled or nailed in place. Meets OSHA 1910.144 for marking physical hazards.

Material Identification: Nominal 3 Mil Polyethylene, 3" & 6" wide
Test Procedure: ASTM-D-882, Method A
Specimen Conditions: 73°F / 50% R.H.
Test Temperature: 73°F
Elongation: 465%
Tensile Strength (Transverse): 1750 psi
Tensile Strength (Longitudinal): 2425 psi
Roll Weight (3" x 1000'): 3.25 lbs

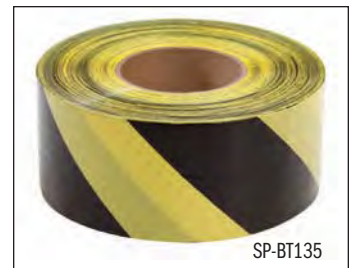

* Barricade tapes are packaged in bags.

Tapes Underground Tape

CATALOG NUMBER	UPC NUMBER	COLOR	LEGEND	MIL THICKNESS	SIZE	STD PAK PCS/PKG	CASE QTY	WEIGHT/PKG (lbs.)
3" x 1000 FT								
SP-UT300	78103581472	Orange	Caution Buried Cable TV Line Below	4 Mil	3" x 1000 Ft	1 Roll	12	4.91
SP-UT305	78103581485	Yellow	Caution Buried Electric Line Below	4 Mil	3" x 1000 Ft	1 Roll	12	4.91
SP-UT310	78103581486	Red	Caution Buried Electric Line Below	4 Mil	3" x 1000 Ft	1 Roll	12	4.91
SP-UT315	78103581487	Orange	Caution Buried Telephone Line Below	4 Mil	3" x 1000 Ft	1 Roll	12	4.91
SP-UT320	78103581488	Yellow	Caution Buried Gas Line Below	4 Mil	3" x 1000 Ft	1 Roll	12	4.91
SP-UT325	78103581489	Yellow	Caution Buried High Voltage Line Below	4 Mil	3" x 1000 Ft	1 Roll	12	4.91
SP-UT330	78103581490	Red	Caution Buried High Voltage Line Below	4 Mil	3" x 1000 Ft	1 Roll	12	4.91
SP-UT335	78103581491	Yellow	Caution Buried Natural Gas Line Below	4 Mil	3" x 1000 Ft	1 Roll	12	4.91
SP-UT340	78103581492	Yellow	Caution Buried Utilities Underground	4 Mil	3" x 1000 Ft	1 Roll	12	4.91
SP-UT345	78103581493	Yellow	Caution Buried Utility Line Below	4 Mil	3" x 1000 Ft	1 Roll	12	4.91
SP-UT350	78103581494	Orange	Caution Buried Fiber Optic Line Below	4 Mil	3" x 1000 Ft	1 Roll	12	4.91



SP-UT300



SP-UT305



SP-UT310



SP-UT315



SP-UT320



SP-UT325



SP-UT330



SP-UT335



SP-UT340



SP-UT345



SP-UT350



Vivid color-coded Underground Tapes quickly warn excavation crews of the existence of buried pipes and cables before damage can occur. Our non-adhesive polyethylene Underground Tape is a simple, economical way to protect buried utility lines. Tapes are impervious to alkalis, acids and other soil components. Available in 3" x 1000' and 6" x 1000' lengths from stock or other widths available by special order. These tapes are printed with many stock legends or can be printed with your own custom wording. Meets APWA recommended color codes.

Underground tape should be installed 12"-18" below ground level and 12" directly above buried pipes, cables and conduits, before final backfilling. Installation of underground tape should be supervised by a professional or authority concerned with the proper use of the product.

Tapes Underground Tape

CATALOG NUMBER	UPC NUMBER	COLOR	LEGEND	MIL THICKNESS	SIZE	STD PAK PCS/PKG	CASE QTY	WEIGHT/PKG (lbs.)
6" x 1000 FT								
SP-UT600	78103581495	Orange	Caution Buried Cable TV Line Below	4 Mil	6" x 1000 Ft	1 Roll	12	9.82
SP-UT605	78103581496	Yellow	Caution Buried Electric Line Below	4 Mil	6" x 1000 Ft	1 Roll	12	9.82
SP-UT610	78103581497	Red	Caution Buried Electric Line Below	4 Mil	6" x 1000 Ft	1 Roll	12	9.82
SP-UT615	78103581498	Orange	Caution Buried Telephone Line Below	4 Mil	6" x 1000 Ft	1 Roll	12	9.82
SP-UT620	78103581499	Yellow	Caution Buried Gas Line Below	4 Mil	6" x 1000 Ft	1 Roll	12	9.82
SP-UT625	78103581500	Yellow	Caution Buried High Voltage Line Below	4 Mil	6" x 1000 Ft	1 Roll	12	9.82
SP-UT630	78103581501	Red	Caution Buried High Voltage Line Below	4 Mil	6" x 1000 Ft	1 Roll	12	9.82
SP-UT635	78103581502	Yellow	Caution Buried Natural Gas Line Below	4 Mil	6" x 1000 Ft	1 Roll	12	9.82
SP-UT640	78103581503	Yellow	Caution Buried Utilities Underground	4 Mil	6" x 1000 Ft	1 Roll	12	9.82
SP-UT645	78103581504	Yellow	Caution Buried Utility Line Below	4 Mil	6" x 1000 Ft	1 Roll	12	9.82
SP-UT650	78103581505	Orange	Caution Buried Fiber Optic Line Below	4 Mil	6" x 1000 Ft	1 Roll	12	9.82

Material Identification: 4 Mil Polyethylene, 3", 4" & 6" wide
Test Procedure: ASTM-D-882, Method A
Specimen Conditions: 73°F / 50% R.H.
Test Temperature: 73°F
Elongation: 552%
Tensile Strength (Transverse): 2100 psi
Tensile Strength (Longitudinal): 2870 psi
Roll Weight (3" x 1000'): 6 lbs
Roll Weight (6" x 1000'): 12 lbs



Tapes

Detectable Underground Tape

CATALOG NUMBER	UPC NUMBER	COLOR	LEGEND	MIL THICKNESS	SIZE	STD PAK PCS/PKG	CASE QTY	WEIGHT/PKG (lbs.)
3" x 1000 FT								
SP-DT300	78103581506	Black/Red	Caution Buried Electric Line	4.5 Mil	3" x 1000 Ft	1 Roll	12	5.33
SP-DT305	78103581507	Black/Yellow	Caution Buried Gas Line	4.5 Mil	3" x 1000 Ft	1 Roll	12	5.33
SP-DT310	78103581508	Black/Orange	Caution Buried Cable TV Line	4.5 Mil	3" x 1000 Ft	1 Roll	12	5.33
SP-DT315	78103581509	Black/Red	Caution Buried High Voltage Line	4.5 Mil	3" x 1000 Ft	1 Roll	12	5.33
SP-DT320	78103581510	Black/Orange	Caution Buried Fiber Optic Line	4.5 Mil	3" x 1000 Ft	1 Roll	12	5.33



SP-DT300



SP-DT305



SP-DT310



SP-DT315



SP-DT320

Avoid the problem of costly dig-ins to locate buried, non-metallic cables and pipelines with our Detectable Underground Tape. Providing you with double protection, this tape is easily located with an industrial grade non-ferrous metal detector before you dig, while its highly visible colors make it easy to locate after the dig has begun.

Printed with a black legend on standard APWA colors, our Aluminum Foil tape is double laminated for extra protection.

Colors Available: Red, Orange, Yellow, Green, Blue and Purple.

Conforms to the following specifications:

- NTSB-PSS-73-1
- GSA Public Buildings Service Guide
- American Gas Association 72-D-56
- API RP 1109
- OSHA 1926.956 (c) (1)
- APWA Uniform Color Code
- DOT Office of Pipeline Safety USAS B31.8
Federal Gas Safety Regulations S 192-321 (e)



Tapes Detectable Underground Tape

CATALOG NUMBER	UPC NUMBER	COLOR	LEGEND	MIL THICKNESS	SIZE	STD PAK PCS/PKG	CASE QTY	WEIGHT/PKG (lbs.)
6" x 1000 FT								
SP-DT600	78103581511	Black/Red	Caution Buried Electric Line	4.5 Mil	6" x 1000 Ft	1 Roll	12	10.86
SP-DT605	78103581512	Black/Yellow	Caution Buried Gas Line	4.5 Mil	6" x 1000 Ft	1 Roll	12	10.86
SP-DT610	78103581513	Black/Orange	Caution Buried Cable TV Line	4.5 Mil	6" x 1000 Ft	1 Roll	12	10.86
SP-DT615	78103581514	Black/Red	Caution Buried High Voltage Line	4.5 Mil	6" x 1000 Ft	1 Roll	12	10.86
SP-DT620	78103581515	Black/Orange	Caution Buried Fiber Optic Line	4.5 Mil	6" x 1000 Ft	1 Roll	12	10.86

Material Identification: 4.5 Mil Polyethylene, 2", 3" & 6" wide
Test Procedure: ASTM-D-882, Method A
Specimen Conditions: 73°F / 50% R.H.
Test Temperature: 73°F
Elongation: 90%
Tensile Strength (Transverse): 5530 psi
Tensile Strength (Longitudinal): 4544 psi
Roll Weight (3" x 1000'): +/- 7.5 lbs
Roll Weight (6" x 1000'): +/- 15 lbs

Locatability:

We recommend the use of an industrial grade non-ferrous metal locator utilizing inductive location. The metal mass in the tape is what the locator will pick up so the deeper the burial, the wider the tape should be.

Conductive location is attainable; however, when clipping on to the tape there must be complete contact with the foil. The foil is laminated between 2 layers of plastic making it somewhat difficult to achieve a proper clamp.



SP-DT600



SP-DT605



SP-DT610



SP-DT615



SP-DT620



Tapes

Silicone Self-Fusing Tape

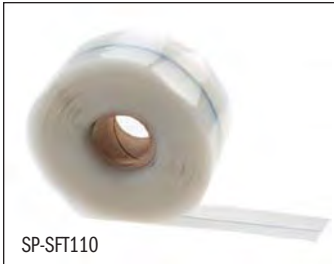
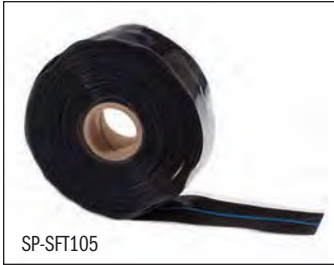
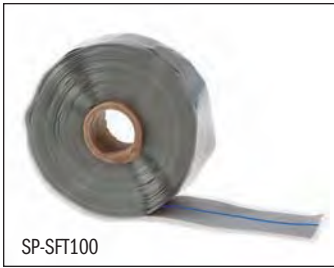

CATALOG NUMBER	UPC NUMBER	COLOR	SIZE	THICKNESS	STD PAK PCS/PKG	PKG STYLE	CASE QTY	WEIGHT/PKG (lbs.)
TRIANGULAR BLUE LINE GUIDE								
SP-SFT100	78103581347	Gray	1" x 36 Ft	020"	1 Roll	Bag	12	.279
SP-SFT105	78103581348	Black	1" x 36 Ft	020"	1 Roll	Bag	12	.279
SP-SFT110	78103581349	Clear	1" x 36 Ft	020"	1 Roll	Bag	12	.279
SP-SFT115	78103581350	Red	1" x 36 Ft	020"	1 Roll	Bag	12	.279
RECTANGULAR								
SP-SFT200	78103581351	Gray	1" x 36 Ft	020"	1 Roll	Bag	12	.368
SP-SFT205	78103581352	Black	1" x 36 Ft	020"	1 Roll	Bag	12	.368
SP-SFT210	78103581353	Clear	1" x 36 Ft	020"	1 Roll	Bag	12	.368
SP-SFT215	78103581354	Red	1" x 36 Ft	020"	1 Roll	Bag	12	.368

Silicone Self-Fusing Tape is an improved wrapping tape extruded of high performance silicone rubber suitable wherever a tough, permanently resilient, void-free insulation is required. On Triangular Blue Guide Line Self-Fusing Silicone Tape, the colored guide line facilitates wrapping and cuts taping time. The triangular shape assures a smooth, uniform finished wrap over difficult shapes, such as coils, splices, bus bars and cable harnesses. Silicone Rubber Tape is self-adhering and self-fusing, curing in 24 hours at room temperature. Faster curing and a harder finish can be accomplished through the application of heat after wrapping. Temperature range is -60°C to 200°C for continuous use; -65°C to 260°C for intermittent use. UL 510 recognized.

Uses

The strength and elasticity of Silicone Self-Fusing Tape makes it ideal for protecting coils from the effects of vibration and shock and will not crack or separate with expansion or contraction stresses. The low dielectric losses and high insulation resistance of Silicone Self-Fusing Tape will not limit performance of a coil over a very wide temperature range. The high thermal conductivity allows generated heat to dissipate rapidly resulting in a lower temperature rise and an increase of available power for a given load. The use of Silicone Self-Fusing Tape makes it possible to easily and quickly reclaim old motors by over-wrapping deteriorated insulation. By the same process extra protection may be added to open frame motors or other equipment in difficult or contaminated locations. May be used in many Class A and Class B applications. High quality Class H insulation systems can be made using Silicone Self-Fusing Tape in combination with Silicone Rubber Tubing.

Specifications

Silicone Self-Fusing Tape meets or exceeds the requirements of MIL CID-A-A-59163, Type I, Rectangular; and Type II, Triangular Guide Line.



Tapes

Silicone Self-Fusing Tape

Characteristics of Silicone Rubber Tape:

PROPERTY	TEST METHOD	PERFORMANCE
Operating Temperature Range:		
Continuous		-60°C to 200°C
Intermittent		-65°C to 260°C
Specific Gravity	ASTM D792	1.2
Hardness, Durometer, Shore A	ASTM D2148	
Room-cured – 24 Hours		50
Cured at 300°F – 24 Hours		70
Cured at 480°F – 24 Hours		75
Tensile Strength, psi, minimum	ASTM D119	700
Elongation, %, minimum	ASTM D119	300
Bond Strength, pounds, minimum	MIL CID-A-A-59163	2 (1" width)
Adhesion, inches unwind, maximum	ASTM D2148	3
Cold Brittle Point, °C, maximum	ASTM D746	-65
Water Absorption, % max, by weight	MIL CID-A-A-59163	3
Dielectric Strength, volts/mil, minimum	MIL CID-A-A-59163	400
Thickness 0.020 inch		400
Dielectric Constant, 1 KHz	ASTM D150	2.95
Dissipation Factor, 1 KHz	ASTM D150	<0.0004
Volume Resistivity, ohms/cm, minimum	MIL CID-A-A-59163	3×10

Above values are typical performance data for FLEXITE Silicone Rubber TGL Tape and are not intended to be used as design data. Other sizes and roll lengths can be supplied, subject to factory quotation upon request.



Tools Shovels



SP-SRP100



SP-SSP115



SP-SRP105



SP-SSP120

CATALOG NO./UPC NUMBER	SHOVEL TYPE/SERIES	BLADE SIZE/THICKNESS	HANDLE LENGTH/OVERALL LENGTH	HANDLE TYPE/MATERIAL	BLADE BACK/SOCKET TYPE	WARRANTY	STD PAK/CASE QTY	WEIGHT/EA (lbs.)
SP-SRP100 78103581289	Round Point Professional	9.4" x 11.9" (#2)/ 1.8mm	48"/ 58.25"	Long/ Fiberglass	Open Back/ 11" Wide Steel Collar	Lifetime	Each/ 3	4.65
SP-SSP115 78103581290	Square Point Professional	9.9" x 11.5" (#2)/ 1.8mm	48"/ 58.25"	Long/ Fiberglass	Open Back/ 11" Wide Steel Collar	Lifetime	Each/ 3	5.00
SP-SRP105 78103581291	Round Point Professional	9.4" x 11.9" (#2)/ 1.8mm	48"/ 58.25"	Long/ Ash Wood	Open Back/ 11" Tab 2 Rivets	Lifetime	Each/ 3	4.70
SP-SSP120 78103581292	Square Point Professional	9.9" x 11.95" (#2)/ 1.8mm	48"/ 58.25"	Long/ Ash Wood	Open Back/ 11" Tab 2 Rivets	Lifetime	Each/ 3	4.80
SP-DSP130 78103581293	16" Drain Spade Professional	5.6" x 16"/ 1.8mm	48"/ 61"	Long/ Ash Wood	Open Back/ 11" Tab 2 Rivets	Lifetime	Each/ 3	4.45
SP-SRP110 78103581294	Round Point Combat	8.6" x 11.25" (#2)/ 1.6mm	29.4"/ 39.4"	D Handle / Wood	Open Back/ 8.5" Rolled Step	5 Years	Each/ 3	2.90
SP-SSP125 78103581295	Square Point Combat	9" x 10.7" (#2)/ 1.6mm	29.4"/ 40.4"	D Handle / Poly	Open Back/ 8.5" Rolled Step	5 Years	Each/ 3	3.15
SP-DSP135 78103581296	14" Drain Spade Combat	5.9" x 14.25" (#2)/ 1.6mm	30.65"/ 44.65"	D Handle / Wood	Open Back/ 9.75" Rolled Step	5 Years	Each/ 3	3.05



SP-DSP130



SP-SRP110



SP-SSP125



SP-DSP135

Tools Post Hole Diggers

CATALOG NO./ UPC NUMBER	DIGGER TYPE/ SERIES	BLADES DESCRIPTION	HANDLE LENGTH/ GRIPS LENGTH	OVERALL LENGTH	HANDLE TYPE/ MATERIAL	WARRANTY	STD PAK/ CASE QTY	WEIGHT/ EA (lbs.)
SP-PHD140 78103581297	Hercules Pattern Post Hole Digger/ Professional	2-Piece Riveted Blades, 2.0mm Steel 6.25" Point Spread	48"/ 9" Grips	59.5"	Long/ Fiberglass	Lifetime	Each/ 2	10.55



SP-PHD140

Rakes

CATALOG NO./ UPC NUMBER	TYPE/ SERIES	HEAD DESCRIPTION	HANDLE LENGTH/ OVERALL LENGTH	HANDLE TYPE/ MATERIAL	WARRANTY	STD PAK/ CASE QTY	WEIGHT/ EA (lbs.)
SP-RST145 78103581298	Pro Forged Road & Stone Rake/ Professional	17" x 4" Head 16 Straight Tines, Steel Ferrule	60"/ 67"	Contoured/ Ash Wood	Lifetime	Each/ 6	4.40
SP-RCT150 78103581299	Pro Forged Level Head Rake/ Professional	16" x 3.25", 16 Curved Tines	60"/ 67"	Contoured/ Ash Wood	Lifetime	Each/ 6	3.60

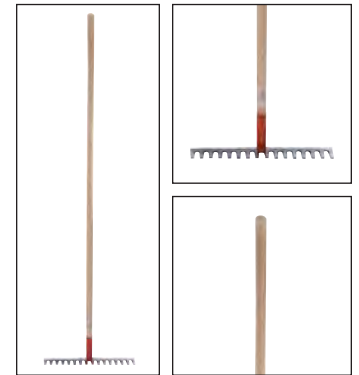

SP-RST145

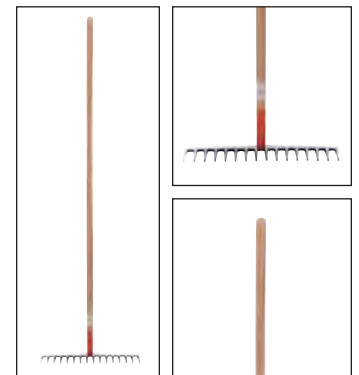

SP-RCT150

Tools & Tape Measures

Pick • Combat Series



CATALOG NUMBER	UPC NUMBER	HEAD DESCRIPTION	HANDLE DESCRIPTION	CONNECTOR/ OVERSTRIKE GUARD	WARRANTY	STD PAK PCS/PKG	CASE QTY	WEIGHT/ EA (lbs.)
SP-PK100	78103581300	5 Lb. Pick Mattock with Forged Head	36" Hardwood Handle	Over-molded Poly	5 Years	Each	3	7.50

Heavy Hammer • Professional Series



CATALOG NUMBER	UPC NUMBER	HEAD DESCRIPTION	HANDLE DESCRIPTION	ASSEMBLY	WARRANTY	STD PAK PCS/PKG	CASE QTY	WEIGHT/ EA (lbs.)
SP-EH105	78103581301	4 Lb. Engineer Hammer with Chamfered Face	16" Premium Hickory	Wedge	Lifetime	Each	4	4.01

Sledge Hammer • Professional Series



CATALOG NUMBER	UPC NUMBER	HEAD DESCRIPTION	HANDLE DESCRIPTION	ASSEMBLY	WARRANTY	STD PAK PCS/PKG	CASE QTY	WEIGHT/ EA (lbs.)
SP-SH110	78103581302	8 Lb. Sledge Hammer with Chamfered Face	36" Premium Hickory	Wedge	Lifetime	Each	4	8.01
SP-SH115	78103581303	10 Lb. Sledge Hammer with Chamfered Face	36" Premium Hickory	Wedge	Lifetime	Each	4	10.00
SP-SH120	78103581304	20 Lb. Sledge Hammer with Chamfered Face	36" Premium Hickory	Wedge	Lifetime	Each	4	22.20

Tape Measures

Titan Quick Read Tape Measures



CATALOG NUMBER	UPC NUMBER	SERIES	SIZE	STD PAK PCS/PKG	PKG STYLE	CASE QTY	WEIGHT/ PKG (lbs.)
SP-TM25	78103581325	Titan Quick Read	25 Foot x 1 Inch Blade	Each	Card	6	0.85
SP-TM33	78103581326	Titan Quick Read	33 Foot x 1 Inch Blade	Each	Card	6	1.05

Features

- 1 inch blades
- Easy, quick-read markings in both inches and centimeters
- Tough, impact resistant plastic case
- Ergonomic cushion grips for maximum comfort
- Hands-free blade lock



Markers Lumber Crayons

CATALOG NUMBER	UPC NUMBER	SERIES	COLOR	STD PAK PCS/PKG	PKG STYLE	CASE QTY	WEIGHT/PKG (lbs.)
SP-LC-RED	78103581320	JOHNSON® TRU-LINE®	Red	12	Box	6	0.68
SP-LC-YLW	78103581321	JOHNSON® TRU-LINE®	Yellow	12	Box	6	0.68
SP-LC-BLU	78103581322	JOHNSON® TRU-LINE®	Blue	12	Box	6	0.68
SP-LC-BLK	78103581323	JOHNSON® TRU-LINE®	Black	12	Box	6	0.47

Lumber Crayons write on various surfaces including wood, concrete, metal, plastic, cardboard, paper and other surfaces.

Features

- Lead free
- Non-toxic
- Weather resistant
- Fade resistant
- Fits lumber crayon holder part number SP-LCH



Lumber Crayon Holder

CATALOG NUMBER	UPC NUMBER	SERIES	MATERIAL	STD PAK PCS/PKG	PKG STYLE	WEIGHT/PKG (lbs.)
SP-LCH	78103581324	Dixon®	Walnut	Each	Carded	0.05

Features

- Holds crayons securely
- Helps prevent crayon breakage
- Fits round or hexagonal crayons or markers
- 1/2" in diameter
- Metal chuck, hole for wrist strap



Permanent Marking Pens

CATALOG NUMBER	UPC NUMBER	SERIES	COLOR	STD PAK PCS/PKG	PKG STYLE	CASE QTY	WEIGHT/PKG (lbs.)
SP-FPM	78103581316	Sharpie® Fine Point	Black	2	Bag	6	0.06
SP-KSM	78103581317	Sharpie® King Size™	Black	1	Bag	6	0.08

Sharpie® Fine Point

The original pen style permanent marker

- The Industry Standard
- Permanent on most surfaces
- Fade and water resistant
- Quick-drying ink AP certified nontoxic formula



Sharpie® King Size™

- Industrial Strength for the toughest marking jobs
- Durable aluminum barrel and felt tip stand up to heavy use
- Excellent for marking corrugate, wood, metal, foil, stone, plastic, leather and more
- Marks on wet and oily surfaces
- Water resistant and dries quickly



Duct Seal



CATALOG NUMBER	UPC NUMBER	SIZE	STD PAK PCS/PKG	PKG STYLE	CASE QTY	WEIGHT/PKG (lbs.)
SP-DS1P	78103581327	1 Lb.	2	Bag	10	1.00
SP-DS5P	78103581328	5 Lb.	1	Bag	10	5.00

Duct seal is used to seal around junction boxes, flashing and service entrances. Duct seal is a permanently soft, non toxic compound that can be painted almost immediately after application. It will also not affect other plastic materials or corrode metals.

Product Specs:

SIZE	COMPLIANCE
1 Lb. or 5 Lb.	UL

Application

This duct seal is used to seal around junction boxes, flashing and service entrances.

Advantages

Duct seal is a permanently soft, nontoxic compound that can be painted almost immediately after application. It will also not affect other plastic materials or corrode metals.

Field Names

Duck seal, duct seal, duct filler.



Knockout Seals

Snap-In Knockout Seals

CATALOG NUMBER*	UPC NUMBER	SIZE	STD PAK PCS/PKG	PKG STYLE*	CASE QTY	WEIGHT/PKG (lbs.)
SP-KOS12J	78103581329	1/2"	100	Jar	12 Jars	1.44
SP-KOS34J	78103581330	3/4"	100	Jar	12 Jars	1.62
SP-KOS1J	78103581331	1"	100	Jar	12 Jars	2.10
SP-KOS114J	78103581332	1-1/4"	50	Jar	12 Jars	1.45
SP-KOS112J	78103581333	1-1/2"	50	Jar	12 Jars	2.14
SP-KOS2J	78103581334	2"	25	Jar	12 Jars	1.44

Snap-in style knockout seals are inserted in discontinued, open box knockouts to protect exposed wires. They are used in standard, air tight or dust tight applications. Snap-in knockouts seal, close and secure open knockout holes without removing box devices or covers.

Product Specs:

MATERIAL
Steel

Application

These snap-in style knockout seals are inserted in discontinued open box knockouts to protect exposed wires.

Advantages

Snap-in knockout seals, close and secure open knockout holes without removing box devices or covers.

Field Names

Closure plugs, knockout plug, knockout seal, KO seal, knockout filler, snap-in plugs, snap in KO seal.



* Jar version part number shown. Box and Bulk versions may be available. Contact Selecta for availability, part number and pricing.

Screw/Bar Type Knockout Seals



CATALOG NUMBER	UPC NUMBER	SIZE	STD PAK PCS/PKG	PKG STYLE	CASE QTY	WEIGHT/PKG (lbs.)
SP-KOSBT12J	78103581335	1/2"	100	Jar	12 Jars	2.62
SP-KOSBT34J	78103581336	3/4"	50	Jar	12 Jars	1.73
SP-KOSBT1J	78103581337	1"	25	Jar	12 Jars	1.33
SP-KOSBT114J	78103581338	1-1/4"	25	Jar	12 Jars	1.74
SP-KOSBT112J	78103581339	1-1/2"	10	Jar	12 Jars	1.03
SP-KOSBT2J	78103581340	2"	10	Jar	12 Jars	1.46
SP-KOSBT212	78103581341	2-1/2"	10	Box	N/A	2.16
SP-KOSBT3	78103581342	3"	10	Box	N/A	3.11
SP-KOSBT312	78103581343	3-1/2"	10	Box	N/A	3.97
SP-KOSBT4	78103581344	4"	10	Box	N/A	5.81
SP-KOSBT5	78103581345	5"	10	Box	N/A	13.33
SP-KOSBT6	78103581346	6"	10	Box	N/A	14.10

These screw/bar type knockout seals are inserted in discontinued, open box knockouts to protect exposed wires. They are used in standard, air tight or dust tight applications when they have gaskets. One piece preassembled screw and backer bar slides in open knockout holes without removing box devices or covers.

Product Specs:

MATERIAL	PREINSTALLED GASKET
Steel	No

Application

These screw/bar type knockout seals are inserted in discontinued open box knockouts to protect exposed wires. They are used in standard, air tight or dust tight applications when they have a gasket.

Advantages

One piece preassembled screw and backer bar slides in open knockout holes without removing box devices or covers.

Field Names

Closure plugs, knockout plug, knockout seal, KO seal, knockout filler.

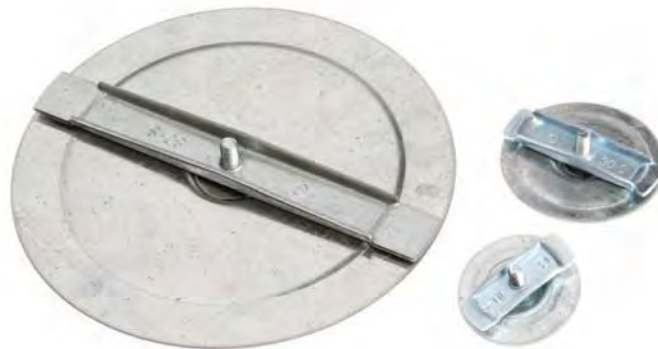

Chemicals

Related Chemicals Products for Fasteners from CRC[^]

Cutting Oil

CATALOG NUMBER	UPC NUMBER	SIZE	STD PAK	PKG STYLE	CASE QTY	WEIGHT/ PKG (lbs.)
14050	66119146047	16 oz. Aerosol Can	1	Can	12	1.00
14051	66119146387	1 Gallon Bottle	1	Bottle	4	8.50

Superior thread cutting lubricant for use on all types of both ferrous and non-ferrous metals, including brass, copper and aluminum.

- Reduces heat and friction to ease cutting and increase cutting tool life
- Sulfur-free, low odor formula
- Excellent anti-weld properties
- Foaming aerosol formulation clings to vertical surfaces
- Compatible with all manual and motor-driven threading equipment
- NSF P1 Registered
- Made in the USA



CRC Cutting Oil Specs:



TYPE	COLOR	METAL COMPATIBILITY
Petroleum	Amber	All Metals

All CRC products are available. Contact Selecta for details.



Zinc-It[®] Instant Cold Galvanize[™]

CATALOG NUMBER	UPC NUMBER	SIZE	STD PAK	PKG STYLE	CASE QTY	WEIGHT/ PKG (lbs.)
18412*	66119146078	16 oz. Aerosol Can	1	Can	12	1.25

High-performance coating of >92% pure zinc that electrochemically bonds with ferrous metals to form a galvanic cell. ZINC-IT is an excellent touch-up for damaged galvanized coating.

- Actively fights rust and corrosion with a film of >92% pure zinc
- Protects base metal even when scratched, abraded or dented
- Fast-drying, dries to the touch in 15 minutes
- Excellent weldability
- Made in the USA



CRC Zinc-It[®] Instant Cold Galvanize[™] Specs:



FILM TYPE	APPLICATION	CORROSION PROTECTION	DRYING TIME (TO TOUCH)	SPECIFICATIONS
Zinc, Dry	Outdoors: 1-2 Years	Heavy	15-30 Minutes	Aerosol: MIL-P-46105 (MR) Paragraph 3.2, 3.3.1, 3.5.8, 4.4.5; MIL-P-21035 (SHIPS) Paragraph 3.3.1, 3.3.2, 3.3.3; DOD-P-21035A (NAVY) Paragraph 3.1, 3.2, 3.5.3, 3.5.6, 4.4.3, 6.1, 6.5, 353; & MIL-T-26433 ASTM-780-01 Section 4.2.2 Bulk: DOD-P-21035; MIL-P-46105; MIL-P-26915; MIL-T-26433

This product is labeled extremely flammable. Read and observe the special usage warning on the label. Do not apply while equipment is energized

[^] All products from CRC are available. The products shown in this section are for reference only as being related with fastener products. Contact Selecta for details on other CRC products.

* This product is labeled extremely flammable. Read and observe the special usage warning on the label. Do not apply while equipment is energized.

Chemicals

Related Chemicals Products for Fasteners from CRC[^]

Bright Zinc-It[®] Instant Cold Galvanize[™]



This product is labeled extremely flammable. Read and observe the special usage warning on the label. Do not apply while equipment is energized

CATALOG NUMBER	UPC NUMBER	SIZE	STD PAK	PKG STYLE	CASE QTY	WEIGHT/ PKG (lbs.)
18414*	66119147668	16 oz. Aerosol Can	1	Can	12	1.08

Epoxy-ester based, light duty sacrificial zinc coating that inhibits corrosion and provides the beauty of a high shine bright metallic finish. Recommended for touch-up and repair of bright finish, hot-dip galvanized surfaces.



- Protects base metal even when scratched or abraded
- Fast-drying, dries to the touch in 15 minutes
- Made in the USA



CRC Bright Zinc-It[®] Instant Cold Galvanize[™] Specs:

FILM TYPE	APPLICATION	CORROSION PROTECTION	DRYING TIME (TO TOUCH)	SPECIFICATIONS
Zinc, Dry	Outdoors: Up to 1 Year	Moderate	15-30 Minutes	ASTM-A-750-93

Minimal Expansion Foam



Always Wear Safety Glasses & Gloves

CATALOG NUMBER	UPC NUMBER	DESCRIPTION	STD PAK	PKG STYLE	CASE QTY	WEIGHT/ PKG (lbs.)
14077	661191460560	16 oz. Aerosol Can	1	Can	12	0.83

Polyurethane foam designed to fill, seal, bond, retrofit, insulate and deaden sound in and around cracks and cavities. It forms a permanent, waterproof and airtight bond to masonry, wood, glass, metal & most plastics.



- Stops drafts, dust, moisture, insects and rodents
- When cured, foam can be sanded, painted or stained
- The low expansion formula expands 50% when fully cured
- Cured foam insulates to R-5 for each inch of foam
- UL[®] classified as a caulking sealant
- Foam and propellant are non-flammable
- Convenient 360° valve – can be sprayed from any position
- Reusable for up to 30 days after initial use
- Made in the USA



CRC Minimal Expansion Foam Specs:

ROOM TEMP. CURING	CORROSIVE TO METALS	TEMPERATURE RANGE	CONFORMS TO SPECIFICATIONS
Yes	No	-200° to 200° F (cured foam)	Insulates to R-5

All CRC products are available. Contact Selecta for details.

[^] All products from CRC are available. The products shown in this section are for reference only as being related with fastener products. Contact Selecta for details on other CRC products.

* This product is labeled extremely flammable. Read and observe the special usage warning on the label. Do not apply while equipment is energized.



Made in the USA



No one knows spray paint like Rust-Oleum. Our time tested line of industrial maintenance spray paints are designed to meet the diverse project needs of our customers. From applications where just a simple touch up or color change is needed to long-term rust protection on metal, Rust-Oleum has it all. Our products are designed for maximum coverage, durability, ease of use and comfort so painting is fast and easy with professional results every time.

High Performance

The ultimate protection for industrial environments. Formulated with the highest quality pigments and resins, the High Performance brand of coatings has the highest paint solids in the industry. These proprietary formulations are designed for severe industrial environments and are backed by a Rust-Proof Guarantee. The High Performance brand is the foundation of Rust-Oleum Corporation. This product line can be found on pages T-7 to T-10.



Industrial Choice

The best performing multi-purpose line of coatings. When you do not need the ultimate protection for severe industrial environments that our High Performance brand provides, we offer Industrial Choice. Industrial Choice by Rust-Oleum is our multi-purpose line of coatings that outperforms the competition. This complete line of coatings is designed for mild to moderate industrial environments, and complements our High Performance offering, making Rust-Oleum the best choice for all of your coating needs. This product line can be found on pages T-11 to T-17.

















Rust-Oleum Product Line



**Rust-Oleum • High Performance
V2100 System Rust Preventive Enamel**



 Tan	 Dark Machine Gray	 Flat Black
 Deep Blue	 Light Machine Gray	 Gloss White
 Dark Green	 Silver Aluminum	 Semi-Gloss White
 Industrial Yellow	 Gloss Black	 Flat White
 Bright Red	 Semi-Gloss Black	 Crystal Clear



V2100 System Safety Colors

 Safety Blue	 Safety Orange	 Safety Yellow
 Safety Green	 Safety Red	

V2100 System Fluorescents

 Fluorescent Orange	 Fluorescent Red	 Fluorescent Yellow
--	---	--

V2100 System Equipment

 Caterpillar Yellow (old)	 Equipment Yellow
--	--

V2100 System Enamel Primer



 Red Primer	 Gray Primer
--	---

V2100 System Galvanizing Compound



 Cold Galvanizing Compound

V2100 System High Heat Coating



 High Heat Aluminum	 High Heat Black
--	---

V2100 System Rust Reformer®



 Rust Reformer



Safety Color Coding Guide

Based on the original OSHA code



Emergency

Use RED for the identification of fire protection equipment and apparatus, danger and stop.



Warning

Use ORANGE for designating dangerous parts of machines or energized equipment which may cut, crush, shock, or otherwise injure, and to emphasize such hazards when enclosure doors are open or removed, or when gear, belt or other guards around moving equipment are open or removed, exposing unguarded hazards.



Caution

Use YELLOW for designating caution and for marking physical hazards such as striking against, stumbling, falling, tripping, and "caught in between". Solid yellow, and yellow with black stripes or checkers should be used interchangeably, using the combination which will attract the most attention in the particular area.



Safety Equipment

Use GREEN or similar color for designating safety and the location of First Aid equipment (other than firefighting equipment). Green background with a white cross is accepted as identifying First Aid equipment.



Safety Information

Use BLUE for identification of safety information used on informational signs and bulletin boards. In railroad areas only, blue shall be the color for designating caution, limited to warning against the starting, the use of, or the movement of equipment under repair or being worked on.



Traffic/Housekeeping

Use BLACK & WHITE to designate traffic and housekeeping markings. Solid white, solid black, single color striping, alternate stripes of black and white, or black and white checkers should be used in accordance with local conditions. (Purple, gray and brown may be used to accentuate color contrast and make other colors more visible.)

Identification of Piping Systems

Complies with the American National Standards Institute ANSI A13.1-1981 recommendations.



Fire Protection & Sprinkler Piping

RED is for ANSI Class F-FIRE. This classification includes sprinkler systems and other fire protection equipment.



Dangerous Materials

YELLOW is for ANSI Class D. This group includes materials which are hazardous to life or property because they are easily ignited, toxic, corrosive at high temperatures and pressures, produce poisonous gas, or are themselves poisonous.



Safe Materials

GREEN is for ANSI Class S. This group includes those materials involving little or no hazard to life or property in their handling.



Protective Materials

BLUE is for ANSI Class P. This group includes materials which are piped through plants for the express purpose of being able to prevent or minimize the hazard of dangerous materials.

Rust-Oleum Product Line

• TRUSTED QUALITY SINCE 1921 •
RUST-OLEUM[®]
INDUSTRIAL
— CHOICE —

**Rust-Oleum • Industrial Choice
1600 System Multi-Purpose Enamel**

 Almond	 Cherry Red	 Semi-Flat Black
 Leather Brown	 Universal Gray	 Gloss White
 True Blue	 Machinery Gray	 Flat White
 Regal Blue	 Dull Aluminum	 Crystal Clear
 Hunter Green	 Glossy Black	
 Banner Red	 Ultra-Flat Black	

1600 System Safety Colors

 Safety Blue	 Safety Orange	 Safety Red
 Safety Green	 Safety Purple	 Safety Yellow

1600 System Fluorescents

 Fluorescent Green	 Fluorescent Red-Orange	 Fluorescent Yellow
 Fluorescent Orange	 Fluorescent Pink	

1600 System Primers

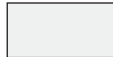
 Red Primer	 Gray Primer	 White Primer
--	---	--

**Rust-Oleum • Industrial Choice
1600 System Galvanizing Compound**

 Cold Galvanizing Compound

**Rust-Oleum • Industrial Choice
RB1600 System Green Rebar Epoxy**

 Green Rebar



Paint

Rust-Oleum Product Line



Rust-Oleum • Industrial Choice M1400 Construction Line Marking Paint

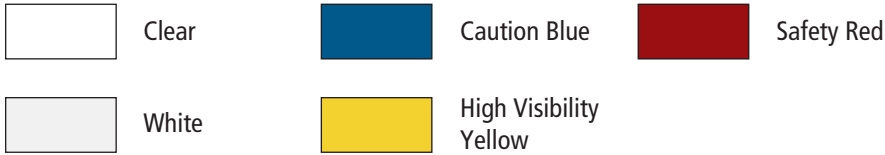

M1400 System Fluorescents



Rust-Oleum • Industrial Choice M1600 Solvent-Based Precision Line® Inverted Marking Paint

M1600 Solvent-Based Colors

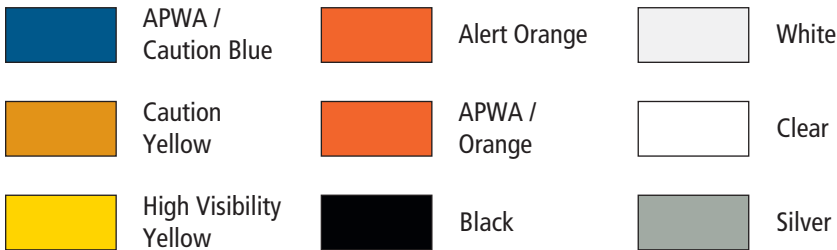

M1600 System Safety Colors

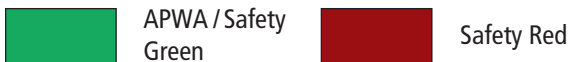

M1600 System Fluorescents









• TRUSTED QUALITY SINCE 1921 •
RUST-OLEUM®
 INDUSTRIAL
 — CHOICE —

Rust-Oleum Product Line

• TRUSTED QUALITY SINCE 1921 •
RUST-OLEUM[®]
INDUSTRIAL
— CHOICE —

**Rust-Oleum • Industrial Choice
M1800 Water-Based Precision Line[®] Inverted Marking Paint**

M1800 Water-Based Colors

	APWA / Caution Blue		APWA / Alert Orange		Clear
	Caution Yellow		Black		
	High Visibility Yellow		White		

M1800 System Safety Colors

	APWA / Safety Green		Safety Purple		Safety Red
---	------------------------	---	---------------	---	------------

M1800 System Fluorescents

	Fluorescent Blue		Fluorescent Red-Orange		Fluorescent Orange
	Fluorescent Purple		Fluorescent Green		Fluorescent Pink
	Fluorescent Red				

APWA Uniform Color Code

YELLOW	Gas, oil, steam, petroleum, gaseous materials
RED	Electric power lines, cables, conduit, lighting cables
PURPLE	Reclaimed water, irrigation, slurry lines
BLUE	Potable water
GREEN	Sewers and drain lines
WHITE	Proposed excavation
PINK	Temporary survey markings
ORANGE	Communication, alarm/signal lines, cables, conduit

Total Linear Feet Comparison





**Rust-Oleum • High Performance
V2100 System Rust-Preventive Enamel**



CATALOG NUMBER	UPC NUMBER	CAN SIZE	NET WEIGHT	COLOR	STD PAK	PKG STYLE	CASE QTY	WEIGHT/ CASE (lbs.)
COLORS (15 OZ.)								
V2171838	63290988936	20 oz.	15 oz.	Tan	1	Can	6	8.40
V2125838	63290988946	20 oz.	15 oz.	Deep Blue	1	Can	6	8.40
V2137838	63290988944	20 oz.	15 oz.	Dark Green	1	Can	6	8.40
V2147838	63290988942	20 oz.	15 oz.	Industrial Yellow	1	Can	6	8.40
V2164838	63290988938	20 oz.	15 oz.	Bright Red	1	Can	6	8.40
V2187838	63290988928	20 oz.	15 oz.	Dark Machine Gray	1	Can	6	8.40
V2183838	63290988930	20 oz.	15 oz.	Light Machine Gray	1	Can	6	8.40
V2115838	63290988949	20 oz.	14 oz.	Silver Aluminum	1	Can	6	8.40
V2179838	63290988932	20 oz.	15 oz.	Gloss Black	1	Can	6	8.40
V2177838	63290988934	20 oz.	15 oz.	Semi-Gloss Black	1	Can	6	8.40
V2178838	63290988933	20 oz.	15 oz.	Flat Black	1	Can	6	8.40
V2192838	63290988926	20 oz.	15 oz.	Gloss White	1	Can	6	8.40
209567	63290989015	20 oz.	15 oz.	Semi Gloss White	1	Can	6	8.40
V2190838	63290988927	20 oz.	15 oz.	Flat White	1	Can	6	8.40
V2102838	63290988950	20 oz.	14 oz.	Crystal Clear	1	Can	6	8.40



V2171838



V2125838



V2137838



V2147838

The ultimate spray paint for industrial applications.
Provides maximum corrosion protection and long lasting durability.

- High paint solids provide excellent coverage in one-coat
- New any-angle spray can be sprayed in any direction, even upside down
- New high output tip covers 50% faster, requiring less downtime
- Dries fast – 20 minutes to touch
- Superior gloss retention
- Tough, professional finish provides superior resistance to chipping, cracking and peeling
- Can be used on surfaces that reach temperatures up to 200°F
- Available in a hammered finish to conceal flaws on scratched, rusted or pitted metal
- Meets USDA requirements for incidental food contact

For use on:

- Structural steel
- Handrails
- Piping & storage tanks
- Equipment & machinery



Made in the USA



V2164838



V2187838



V2183838



V2115838



V2179838



V2177838



V2178838



V2192838



209567



V2190838



V2102838



**Rust-Oleum • High Performance
V2100 System Rust-Preventive Enamel**



V2124838



V2133838



V2155838



V2163838



V2143838



2255838



2264838



2242838

CATALOG NUMBER	UPC NUMBER	CAN SIZE	NET WEIGHT	COLOR	STD PAK	PKG STYLE	CASE QTY	WEIGHT / CASE (lbs.)
SAFETY COLORS (15 OZ.)								
V2124838	63290988947	20 oz.	15 oz.	Safety Blue	1	Can	6	8.40
V2133838	63290988945	20 oz.	15 oz.	Safety Green	1	Can	6	8.40
V2155838	63290988940	20 oz.	15 oz.	Safety Orange	1	Can	6	8.40
V2163838	63290988939	20 oz.	15 oz.	Safety Red	1	Can	6	8.40
V2143838	63290988943	20 oz.	15 oz.	Safety Yellow	1	Can	6	8.40
FLUORESCENTS (14 OZ.)								
2255838	63290988955	20 oz.	14 oz.	Fluorescent Orange	1	Can	6	8.40
2264838	63290988954	20 oz.	14 oz.	Fluorescent Red	1	Can	6	8.40
2242838	63290988956	20 oz.	14 oz.	Fluorescent Yellow	1	Can	6	8.40
EQUIPMENT (15 OZ.)								
209715	63290989014	20 oz.	15 oz.	Caterpillar Yellow (Old)	1	Can	6	8.40
V2148838	63290988941	20 oz.	15 oz.	Equipment Yellow	1	Can	6	8.40

The ultimate spray paint for industrial applications. Provides maximum corrosion protection and long lasting durability.

- High paint solids provide excellent coverage in one-coat
- New any-angle spray can be sprayed in any direction, even upside down
- New high output tip covers 50% faster, requiring less downtime
- Dries fast – 20 minutes to touch
- Superior gloss retention
- Tough, professional finish provides superior resistance to chipping, cracking and peeling
- Can be used on surfaces that reach temperatures up to 200°F
- Available in a hammered finish to conceal flaws on scratched, rusted or pitted metal
- Meets USDA requirements for incidental food contact

For use on:

- Structural steel
- Handrails
- Piping & storage tanks
- Equipment & machinery



Made in the USA



209715



V2148838

APPLICATION

SUBSTRATE

STEEL

WOOD

MASONRY

VOC g/l

**COMPLIANT
NATIONWIDE**

**Rust-Oleum • High Performance
 V2100 System Enamel Primer**



CATALOG NUMBER	UPC NUMBER	CAN SIZE	NET WEIGHT	COLOR	STD PAK	PKG STYLE	CASE QTY	WEIGHT/ CASE (lbs.)
COLORS (15 OZ.)								
V2169838	63290988937	20 oz.	15 oz.	Red Primer	1	Can	6	8.40
V2182838	63290988931	20 oz.	15 oz.	Gray Primer	1	Can	6	8.40

Fast-drying primer adds twice the protection and enhances the appearance of the topcoat.

- Can be topcoated any time
- Use anywhere extra protection is needed on rusted, bare or previously painted metal
- Better corrosion protection than other industrial rust-preventive aerosol primers
- Meets USDA requirements for incidental food contact

For use on:

- Structural steel
- Handrails
- Piping & storage tanks
- Equipment & machinery



Made in the USA

APPLICATION



SUBSTRATE



STEEL WOOD



MASONRY

VOC g/l

COMPLIANT NATIONWIDE



V2169838



V2182838

**Rust-Oleum • High Performance
 V2100 System Galvanizing Compound**



CATALOG NUMBER	UPC NUMBER	CAN SIZE	NET WEIGHT	COLOR	STD PAK	PKG STYLE	CASE QTY	WEIGHT/ CASE (lbs.)
COLORS (20 OZ.)								
V2185838	63290988929	20 oz.	20 oz.	Cold Galvanizing Compound	1	Can	6	8.40

Zinc-rich coatings contain up to 93% pure zinc to provide maximum corrosion protection through galvanic protection.

- Excellent adhesion to galvanized metal
- Dries fast – 20 minutes to touch
- Maximum corrosion protection ideal for use in moderate to severe environments
- Meets the performance requirements of Federal Specifications DOD-P-21035A; MIL-P-26915C
- Can be used on surfaces that reach temperatures up to 200°F
- Meets USDA requirements for incidental food contact

For use on:

- Damaged galvanized steel
- Production welds
- Fences & bridges
- Tanks & utility towers and more!
- Vehicles & trailers



Made in the USA

APPLICATION

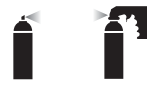

SUBSTRATE



GALVANIZED

VOC g/l

COMPLIANT NATIONWIDE



V2185838



Rust-Oleum • High Performance V2100 System High Heat Coating



V2116838



V2176838

CATALOG NUMBER	UPC NUMBER	CAN SIZE	NET WEIGHT	COLOR	STD PAK	PKG STYLE	CASE QTY	WEIGHT/ CASE (lbs.)
COLORS (15 OZ.)								
V2116838	63290988948	20 oz.	15 oz.	High Heat Aluminum	1	Can	6	8.40
V2176838	63290988935	20 oz.	15 oz.	High Heat Black	1	Can	6	8.40

Heat-resistant coating for objects that reach temperatures up to 1,000°F.

- Direct-to-metal (DTM) spray protects against corrosion
- Dries fast – 20 minutes to touch
- Durable, long-lasting finish
- Meets USDA requirements for incidental food contact

For use on:

- Boilers & steam pipes
- Vents & exhaust pipes
- Kilns



Made in the USA

APPLICATION

SUBSTRATE

METAL

VOC g/l

COMPLIANT NATIONWIDE



Rust-Oleum • High Performance V2100 System Rust Reformer®



215634

CATALOG NUMBER	UPC NUMBER	CAN SIZE	NET WEIGHT	COLOR	STD PAK	PKG STYLE	CASE QTY	WEIGHT/ CASE (lbs.)
COLORS (15 OZ.)								
215634	63290989012	20 oz.	15 oz.	Black	1	Can	6	8.40

Convenient aerosol rust-converter instantly stops existing and future corrosion in one step.

- Neutralizes rust and prevents it from coming back
- Dries fast – 12 minutes to touch
- Dries to a hard, flat black finish that can be topcoated with oil or latex coatings
- Protects against corrosion better than other rust converters on the market
- Can be used on surfaces that reach temperatures up to 200°F
- Meets USDA requirements for incidental food contact

For use on:

- Hard to reach areas & minimal surface prep projects
- Complex shapes
- Equipment
- Railings



Made in the USA

APPLICATION

SUBSTRATE

RUSTED METAL

VOC g/l

COMPLIANT NATIONWIDE

Rust-Oleum • Industrial Choice
1600 System Multi-Purpose Enamel

CATALOG NUMBER	UPC NUMBER	CAN SIZE	NET WEIGHT	COLOR	STD PAK	PKG STYLE	CASE QTY	WEIGHT/ CASE (lbs.)
COLORS (12 OZ.)								
1672830	63290988974	16 oz.	12 oz.	Almond	1	Can	6	7.02
1674830	63290988973	16 oz.	12 oz.	Leather Brown	1	Can	6	7.02
1626830	63290988993	16 oz.	12 oz.	True Blue	1	Can	6	7.02
1622830	63290988995	16 oz.	12 oz.	Regal Blue	1	Can	6	7.02
1638830	63290988989	16 oz.	12 oz.	Hunter Green	1	Can	6	7.02
1666830	63290988978	16 oz.	12 oz.	Banner Red	1	Can	6	7.02
1664830	63290988979	16 oz.	12 oz.	Cherry Red	1	Can	6	7.02
1686830	63290988965	16 oz.	12 oz.	Universal Gray	1	Can	6	7.02
202214	63290989035	16 oz.	12 oz.	Machinery Gray	1	Can	6	7.02
1614830	63290988996	16 oz.	12 oz.	Dull Aluminum	1	Can	6	7.02
1679830	63290988969	16 oz.	12 oz.	Gloss Black	1	Can	6	7.02
1676830	63290988971	16 oz.	12 oz.	Ultra-Flat Black	1	Can	6	7.02
1678830	63290988970	16 oz.	12 oz.	Semi-Flat Black	1	Can	6	7.02
1692830	63290988963	16 oz.	12 oz.	Gloss White	1	Can	6	7.02
1690830	63290988964	16 oz.	12 oz.	Flat White	1	Can	6	7.02
1610830	63290988997	16 oz.	12 oz.	Crystal Clear	1	Can	6	7.02



1672830



1674830



1626830



1622830

From Rust-Oleum, the most trusted name in spray paint, Industrial Choice is a multi-purpose spray paint developed for everyday industrial maintenance applications.

- Ultra-coverage formula provides up to two times the coverage of competitive brands – paint more area faster using fewer cans!
- 360° Any Angle Spray allows you to spray in any direction
- Comfort tip reduces finger fatigue
- Dries to touch in only 12 minutes
- High solids formula delivers complete, even coverage
- Protects against chipping, cracking and peeling
- Can be used on surfaces that reach temperatures up to 200°F
- Meets USDA requirements for incidental food contact



Enamel

For use on:

- Tools & motors
- Furniture
- Equipment & color coding
- Ladders
- Lockers



Made in the USA



1638830



1666830



1664830



1686830



202214



1614830



1679830



1676830



1678830



1692830



1690830



1610830

Rust-Oleum • Industrial Choice 1600 System Multi-Purpose Enamel



1624830



1633830



1653830



1670830



1660830



1644830

CATALOG NUMBER	UPC NUMBER	CAN SIZE	NET WEIGHT	COLOR	STD PAK	PKG STYLE	CASE QTY	WEIGHT / CASE (lbs.)
SAFETY COLORS (12 OZ.)								
1624830	63290988994	16 oz.	12 oz.	Safety Blue	1	Can	6	7.02
1633830	63290988991	16 oz.	12 oz.	Safety Green	1	Can	6	7.02
1653830	63290988986	16 oz.	12 oz.	Safety Orange	1	Can	6	7.02
1670830	63290988975	16 oz.	12 oz.	Safety Purple	1	Can	6	7.02
1660830	63290988982	16 oz.	12 oz.	Safety Red	1	Can	6	7.02
1644830	63290988987	16 oz.	12 oz.	Safety Yellow	1	Can	6	7.02
FLUORESCENTS (12 OZ.)								
1632830	63290988992	16 oz.	12 oz.	Fluorescent Green	1	Can	6	7.02
1654830	63290988985	16 oz.	12 oz.	Fluorescent Orange	1	Can	6	7.02
1655830	63290988984	16 oz.	12 oz.	Fluorescent Red-Orange	1	Can	6	7.02
1659830	63290988983	16 oz.	12 oz.	Fluorescent Pink	1	Can	6	7.02
1642830	63290988988	16 oz.	12 oz.	Fluorescent Yellow	1	Can	6	7.02
PRIMERS (12 OZ.)								
1667830	63290988977	16 oz.	12 oz.	Red Primer	1	Can	6	7.02
1680830	63290988968	16 oz.	12 oz.	Gray Primer	1	Can	6	7.02
1681830	63290988967	16 oz.	12 oz.	White Primer	1	Can	6	7.02

From Rust-Oleum, the most trusted name in spray paint, Industrial Choice is a multi-purpose spray paint developed for everyday industrial maintenance applications.

- Ultra-coverage formula provides up to two times the coverage of competitive brands – paint more area faster using fewer cans!
- 360° Any Angle Spray allows you to spray in any direction
- Comfort tip reduces finger fatigue
- Dries to touch in only 12 minutes
- High solids formula delivers complete, even coverage
- Protects against chipping, cracking and peeling
- Can be used on surfaces that reach temperatures up to 200°F
- Meets USDA requirements for incidental food contact



For use on:

Primer

- Structural steel
- Handrails
- Piping & storage tanks
- Equipment & machinery

Enamel

- Tools & motors
- Furniture
- Equipment & color coding
- Ladders
- Lockers



Made in the USA

APPLICATION

SUBSTRATE

STEEL

WOOD

MASONRY

CONCRETE

AND MORE!

VOC g/l

COMPLIANT NATIONWIDE



1654830



1655830



1659830



1642830



1667830



1680830



1681830

**Rust-Oleum • Industrial Choice
1600 System Galvanizing Compound**

CATALOG NUMBER	UPC NUMBER	CAN SIZE	NET WEIGHT	COLOR	STD PAK	PKG STYLE	CASE QTY	WEIGHT / CASE (lbs.)
COLORS (14 OZ.)								
1685830	63290988966	16 oz.	14 oz.	Cold Galvanizing Compound	1	Can	6	7.02

Zinc-rich coating contains a high zinc content for excellent galvanic protection.

- Excellent adhesion to galvanized metal
- Dries fast – 20 minutes to touch
- Meets the performance requirements of Federal Specifications DOD-P-21035A; MIL-P-26915C
- Can be used on surfaces that reach temperatures up to 200°F
- Meets USDA requirements for incidental food contact

For use on:

- Damaged galvanized steel
- Production welds
- Fences & bridges
- Tanks & utility towers and more!
- Vehicles & trailers
- Touch-up & repair

APPLICATION

SUBSTRATE

G
GALVANIZED

VOC g/l

COMPLIANT NATIONWIDE



Made in the USA



1685830

**Rust-Oleum • Industrial Choice
RB1600 System Green Rebar Epoxy**

CATALOG NUMBER	UPC NUMBER	CAN SIZE	NET WEIGHT	COLOR	STD PAK	PKG STYLE	CASE QTY	WEIGHT / CASE (lbs.)
COLORS (14 OZ.)								
261937	63290989008	16 oz.	14 oz.	Green Rebar	1	Can	6	7.02

Designed for the touch-up of rebar coating on the job site.

- Prevents rust and metal rust stains on concrete
- Excellent corrosion and chemical resistance
- Dries fast – 15 minutes to touch

APPLICATION

SUBSTRATE

S
STEEL

VOC g/l

COMPLIANT NATIONWIDE



Made in the USA



261937

Companion Products

**Spray Grip®
#243546**

- Turns any spray can into a spray gun
- Two finger trigger minimizes fatigue
- Unique locking collar keeps can tightly attached
- Trigger safety lock prevents accidental use
- Keeps hands clean



**Comfort Grip®
#241526**

- Ergonomic design provides maximum control while spraying
- Large soft touch trigger reduces finger fatigue
- Durable construction withstands repetitive use



Rust-Oleum • Industrial Choice M1400 Construction Marking Paint



264693

264692



264694



264695



264696



264697



264702



264699

CATALOG NUMBER	UPC NUMBER	CAN SIZE	NET WEIGHT	COLOR	STD PAK	PKG STYLE	CASE QTY	WEIGHT/CASE (lbs.)
COLORS (15 OZ. WATER-BASED)								
264693	63290989006	20 oz.	15 oz.	Clear	1	Can	12	15.20
264692	63290989007	20 oz.	15 oz.	White	1	Can	12	15.20
264694	63290989005	20 oz.	15 oz.	Caution Blue	1	Can	12	15.20
264695	63290989004	20 oz.	15 oz.	High Visibility Yellow	1	Can	12	15.20
264696	63290989003	20 oz.	15 oz.	Safety Red	1	Can	12	15.20
FLUORESCENTS (15 OZ. WATER-BASED)								
264697	63290989002	20 oz.	15 oz.	Fluorescent Orange	1	Can	12	15.20
264702	63290988999	20 oz.	15 oz.	Fluorescent Pink	1	Can	12	15.20
264699	63290989001	20 oz.	15 oz.	Fluorescent Red Orange	1	Can	12	15.20
264700	63290989000	20 oz.	15 oz.	Fluorescent Green	1	Can	12	15.20

The only water-based marking paint needed for any job or landscape applicator.

- Bold, easy to see markings for excellent visibility
- Excellent visibility on concrete, dirt, gravel, wood, and more
- Best resistance against early fading and chalking
- Non-clogging, inverted spray tip won't pop off
- Water-based formula

For use on:

- Utility & construction
- Excavation & surveying
- Landscape & golf course markings



Made in the USA

APPLICATION

SUBSTRATE

CONCRETE

PAVEMENT

GRASS

GRAVEL

AND MORE!

VOC g/l

COMPLIANT
NATIONWIDE

Rust-Oleum • Industrial Choice

M1600 Solvent-Based Precision Line® Inverted Marking Paint

CATALOG NUMBER	UPC NUMBER	CAN SIZE	NET WEIGHT	COLOR	STD PAK	PKG STYLE	CASE QTY	WEIGHT/ CASE (lbs.)
COLORS (17 OZ.)								
203022	63290988825	20 oz.	17 oz.	APWA / Caution Blue	1	Can	12	17.40
203024	63290989033	20 oz.	17 oz.	Caution Yellow	1	Can	12	17.40
203025	63290989032	20 oz.	17 oz.	High Visibility Yellow	1	Can	12	17.40
203026	63290989031	20 oz.	17 oz.	Alert Orange	1	Can	12	17.40
201516	63290989036	20 oz.	17 oz.	APWA / Orange	1	Can	12	17.40
1675838	63290988972	20 oz.	17 oz.	Black	1	Can	12	17.40
203030	63290989027	20 oz.	17 oz.	White	1	Can	12	17.40
1601838	63290988998	20 oz.	17 oz.	Clear	1	Can	12	17.40
239007	63290989011	20 oz.	16 oz.	Silver (16 oz.)	1	Can	12	17.40
SAFETY COLORS (17 OZ.)								
1634838	63290988990	20 oz.	17 oz.	APWA / Safety Green	1	Can	12	17.40
203029	63290989028	20 oz.	17 oz.	Safety Red	1	Can	12	17.40
FLUORESCENTS (17 OZ.)								
1669838	63290988976	20 oz.	17 oz.	Fluorescent Purple	1	Can	12	17.40
1662838	63290988980	20 oz.	17 oz.	Fluorescent Red	1	Can	12	17.40
203028	63290989029	20 oz.	17 oz.	Fluorescent Red-Orange	1	Can	12	17.40
203023	63290989034	20 oz.	17 oz.	Fluorescent Green	1	Can	12	17.40
203027	63290989030	20 oz.	17 oz.	Fluorescent Orange	1	Can	12	17.40
1661838	63290988981	20 oz.	17 oz.	Fluorescent Pink	1	Can	12	17.40

Water and solvent-based marking paints feature a precision-line spray tip for easy-to-read bright, vivid markings for utility, construction, excavation, surveying, landscape, and golf course markings.

- Best resistance against premature fading
- Precision spray tip
- Marks more linear feet per can than other brands
- No mess spray tip keeps paint off fingers
- Locking tip does not pop off
- Virtually no overspray
- Dries fast – less than 5 minutes
- Convenient spray-through cap
- Guaranteed not to clog



Made in the USA



203022

203024



203025

203026

APPLICATION

SUBSTRATE

CONCRETE

PAVEMENT

GRASS

GRAVEL

AND MORE!

VOC g/l

**COMPLIANT
 NATIONWIDE**



201516



1675838



203030



1601838



239007



1634838



203029



1669838



1662838



203028



203023



203027



1661838

Rust-Oleum • Industrial Choice

M1800 Water-Based Precision Line® Inverted Marking Paint



203031 203033



203034 203035



1875838 203039 1801838

CATALOG NUMBER	UPC NUMBER	CAN SIZE	NET WEIGHT	COLOR	STD PAK	PKG STYLE	CASE QTY	WEIGHT / CASE (lbs.)
COLORS (17 OZ.)								
203031	63290989026	20 oz.	17 oz.	APWA / Caution Blue	1	Can	12	17.40
203033	63290989024	20 oz.	17 oz.	Caution Yellow	1	Can	12	17.40
203034	63290989023	20 oz.	17 oz.	High Visibility Yellow	1	Can	12	17.40
203035	63290989022	20 oz.	17 oz.	APWA / Alert Orange	1	Can	12	17.40
1875838	63290988826	20 oz.	17 oz.	Black	1	Can	12	17.40
203039	63290989018	20 oz.	17 oz.	White	1	Can	12	17.40
1801838	63290988962	20 oz.	16 oz.	Clear (16 oz.)	1	Can	12	17.40
SAFETY COLORS (17 OZ.)								
1834838	63290988961	20 oz.	17 oz.	APWA / Safety Green	1	Can	12	17.40
1868838	63290988958	20 oz.	17 oz.	Safety Purple	1	Can	12	17.40
203038	63290989019	20 oz.	17 oz.	Safety Red	1	Can	12	17.40
FLUORESCENTS (17 OZ.)								
205176	63290989017	20 oz.	17 oz.	Fluorescent Blue	1	Can	12	17.40
1869838	63290988957	20 oz.	17 oz.	Fluorescent Purple	1	Can	12	17.40
1862838	63290988959	20 oz.	17 oz.	Fluorescent Red	1	Can	12	17.40
203037	63290989020	20 oz.	17 oz.	Fluorescent Red-Orange	1	Can	12	17.40
203032	63290989025	20 oz.	17 oz.	Fluorescent Green	1	Can	12	17.40
203036	63290989021	20 oz.	17 oz.	Fluorescent Orange	1	Can	12	17.40
1861838	63290988960	20 oz.	17 oz.	Fluorescent Pink	1	Can	12	17.40

Water and solvent-based marking paints feature a precision-line spray tip for easy-to-read bright, vivid markings for utility, construction, excavation, surveying, landscape, and golf course markings.

- Best resistance against premature fading
- Precision spray tip
- Marks more linear feet per can than other brands
- No mess spray tip keeps paint off fingers
- Locking tip does not pop off
- Virtually no overspray
- Dries fast – less than 5 minutes
- Convenient spray-through cap
- Guaranteed not to clog



Made in the USA

APPLICATION

SUBSTRATE

CONCRETE

PAVEMENT

GRASS

GRAVEL

AND MORE!

VOC g/l

COMPLIANT NATIONWIDE



205176 1869838



1862838 203037



203032 203036



1861838

Paint

Rust-Oleum • Companion Products



Striping Machine

#2395000 • Shipping Wt. 21 lbs.

- Creates 2-4" straight lines quickly and easily
- Cover a larger area in a shorter time
- Convenient storage compartment holds 12 extra cans
- Sturdy steel construction
- Collapsible handle for easy storage



Marking Pistol

#210188 • Shipping Wt. 3 lbs.

- Easy, accurate marking
- Light touch spray control
- Comfortable grip



Athletic Field Striping Machine

#206346 • Shipping Wt. 25 lbs.

- Creates 3-6" straight lines quickly and easily
- Cover a larger area in a shorter time
- Convenient storage compartment holds 12 extra cans
- Sturdy steel construction
- Collapsible handle for easy storage
- Large diameter wheels to accommodate high grass conditions



Spray Grip[®]

#243546 • Shipping Wt. .16 lbs.

- Turns any spray can into a spray gun
- Two finger trigger minimizes fatigue
- Unique locking collar keeps can tightly attached
- Trigger safety lock prevents accidental use
- Keeps hands clean



Striping Wand

#2388000 • Shipping Wt. 3 lbs.

- Use for convenient touch-up of lines or stenciling
- Sturdy, lightweight construction



Comfort Grip[®]

#241526 • Shipping Wt. .25 lbs.

- Ergonomic design provides maximum control while spraying
- Large soft touch trigger reduces finger fatigue
- Durable construction withstands repetitive use



Marking Wand

#268476 • Shipping Wt. 1.5 lbs.

- Easy, upright site marking
- Quick and convenient with no mess
- Comfortable grip
- Convenient flag holder
- Lightweight, yet durable construction
- Use with Rust-Oleum Inverted Marking Paint

Rust-Oleum • Specialty Products
NeverWet®



CATALOG NUMBER	UPC NUMBER	CAN SIZE	NET WEIGHT	COLOR	STD PAK	PKG STYLE	CASE QTY	WEIGHT/ CASE (lbs.)
TWO 14 OZ. CANS PER PACKAGE								
275185	63290988821	20 oz.	14 oz.	Clear	1	Kit	6	19.80

Prevents water, mud and ice from sticking to multiple surfaces.

Rust-Oleum® **NeverWet®** is a superhydrophobic system, which is a liquid repelling treatment, that creates a barrier which dramatically repels water, mud, ice and other liquids.



This revolutionary new class of coatings causes water to form nearly perfect spheres, which roll off of the surface keeping items dry and clean. Protects virtually any surface. For use on:

- Metal
- Wood & paper
- Concrete
- Vinyl and more!

Treated with **NeverWet®**

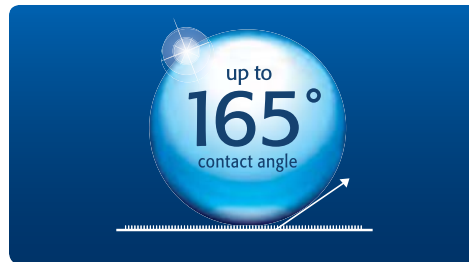

Water, mud and ice roll off **NeverWet®** surfaces due to this extreme contact angle.

Untreated

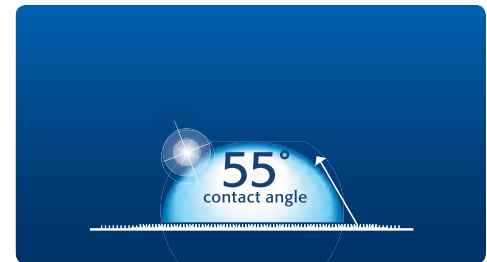

Water, mud and ice pool on typical untreated surfaces.



Rust-Oleum • Specialty Products
V2100 System LeakSeal®

CATALOG NUMBER	UPC NUMBER	CAN SIZE	NET WEIGHT	COLOR	STD PAK	PKG STYLE	CASE QTY	WEIGHT/ CASE (lbs.)
266784	63290988819	20 oz.	15 oz.	Black	1	Can	6	7.80
267453	63290988820	20 oz.	13.75 oz.	Clear	1	Can	6	7.35

Additional colors available: Aluminum, ANSI Gray and Munsell Green. Contact Selecta for details.



An innovative way to fill and seal leaks and cracks in one step.

- Easy to use, rubberized protective utility coating
- Provides a water-tight, flexible seal that prevents moisture penetration, rust, and corrosion
- Dries to a semi-smooth, firm finish that will not sag or drip
- Can be top-coated with latex or alkyd based paints
- Resistant to UV rays
- Works to prevent leaks where liquids are not under pressure
- ANSI Gray and Munsell Green formulated for use on pole top and pad-mount transformers

For use on:

- Buildings, masonry & concrete
- Gutters, tanks & pipes
- Roofing & flashing
- Duct work & PVC
- Containers

APPLICATION

SUBSTRATE

METAL

CONCRETE

PLASTIC

VOC g/l

COMPLIANT NATIONWIDE

PRODUCT ALPHA INDEX

Acoustical Lag Screws	F-2	Fixture Hanging Accessories	F-6	Screws (continued)	
Acoustical Lag Screw Driver	F-2	Foam, Insulating	K-17	Grounding	J-1
Anchors		Glasses, Safety	M-3, 4	Hex Head, Self Tapping	D-3
Drive in, Metal & Plastic	I-6	Gloves	L-1, 2, 3, 4	Hex Head, Self Drilling	D-4, D-6
Drop in, Steel	I-5	Goggles, Safety	K-16, M-4	Hooks, Lag Type	F-3
Double Expansion	I-8	Grounding Clips, Pigtailed, Screws	J-1	Pan Head, Self Tapping	D-1, 2
Hammer Drive Wedge	I-7	Hammer	O-3	Pan Head, Self Drilling	D-5
Hollow Wall	F-2	Hanging, Fixture Accessories	F-6	Raceway & Wireway	J-4
Hollow Block T-Anchors for Hollow Wallblock	I-8	Helmets, Safety	M-1	Round Head Machine Steel, Combo	A-1
Kits - Plastic, Zinc	I-1, 2, 3	Hole Saws	K-10, 11	Round Head Machine Brass, Slotted	A-3
Lag Screw Shield Type	H-4	Hooks, Fixture	F-4	Round Head Machine Stainless, Slotted	A-3
Machine Screw, Lead	I-5	Hooks, S Type	F-4	Self Drilling	D-4, 5
Self Drilling	I-5	Hooks, Screw, Lag Type	F-3	Self Piercing, Quick Drill	D-3
Set-Bolt Anchors	I-8	Jack Chain	F-4	Switch Plate	J-2
Sleeve Type	I-6	Kits		Tamperproof Screws	K-14
Tie Wire Wedge Anchor	I-7	Dial-A-Bit	K-6	Wood Screws	E-3
Wall-Plastic, Metal	I-1, 2, 3	First Aid	K-17, M-2	Setting Tools	I-5
Wedge Type	I-7	Hex Shank Drills	K-2	Shields, Double Expansion	I-8
Wood Screw, Lead	I-8	Hi-Speed Drills	K-3	Shields, Screw, Lag	H-4
Arbors - Hole Saw	K-11	Knives, Utility & Blades	K-16	Shoe Covers	L-4
Beam Clamps	F-5	Nut, Hex; Washer, Flat & Lock	I-9	Ship Auger Bits	K-7
Bits		Nuts, Hex, Zinc-Plated	B-2	Shovels	O-1
Drill	K-1, 2, 3	Screw Extractor & Drill Bit Set	K-3	Staples	
Electricians, Power	K-7	Screw, Machine	I-9	Copper Insulated	J-3
Flat Spade Wood Boring	K-8	Screw, Self Drilling	I-9	Insulated Cable	J-3
Insert, Power Tool	K-4, 5	Screw, Sheet Metal	I-9	Romex Type	J-3
Ship Auger	K-7	Screw, Switch Plate	I-9	Stove Bolts	A-2
Wood Drill	K-13	Screwdriver & Bits	K-4, 5, 6, 13	Straps	
Bolts		Screws, Round & Flat Head Machine	A-4, I-9	Conduit, Drive Type	J-4
Anchor	I-6, 7, 8	Six Way Screwdrivers	K-5	Thinwall-EMT, Rigid	J-4
Carriage with Hex Nuts	H-4	Switch Plate Screws	I-9, J-2	Tamper-Proof Screws	K-14
Eye	F-3	Tap & Drill Bit Set	K-3	Tap Wrench	K-2
Hanger	F-2	Wall Anchors, Plastic, Metal	I-1, 2, 3	Tape Measurers	O-3
Hex, Steel	H-1	Washer, Flat & Lock	C-3, I-9	Tapes	
Hex, Silicon Bronze & Stainless	H-2	Knock-Out Seals	R-1, 2	Electrical	N-1
Lag	H-3	Markers		Duct	N-2
Stove	A-1	Lumber Crayons	P-1	Barricade	N-3
Toggle	F-1	Lumber Crayon Holder	P-1	Underground	N-4, 5
Box Supports	J-1	Permanent Markers	P-1	Underground Detectable	N-6, 7
Bungee Cords	K-16	Mounting Tabs	G-2	Silicone, Self-Fusing	N-8, 9
Cable Clamps & Clips & Tools	G-2	Nail Plates, Safety	J-1	Taps-Carbon Steel	K-2
Cable Staples	J-4	Nuts		Threaded Rod	F-5
Cable Ties	G-1	Hex, Brass	B-1	Tie Wire	F-4
Caulking Gun	K-13	Hex, External Lock Washer	B-2	Toggle Bolts & Wings	F-1
Chain		Hex, Silicon Bronze	B-1	Tools	
Double Loop Lion	F-4	Hex, Stainless Steel	B-1	Cable Tie	G-2
Jack	F-4	Hex, Steel	B-1	Concrete Screw	I-4
Chemicals		Hex, Nylon Insert	B-2	Drive Pin, Hand Drive	F-5
CRC	S-1, 2	Wing, Forged	B-2	Drywall Saw	K-10
Clip-Grounding	J-1	Paint		Hack Saw Frame	K-12
Couplings, Hex Rod	F-5	Rust-Oleum Paint Swatches	T-1, 2, 3, 4, 5, 6	Hammer, Sledge & Heavy	O-3
Double Expansion Shields	I-8	Rust-Oleum High Performance	T-7, 8, 9, 10	Pick	O-3
Drills		Rust-Oleum Industrial Choice	T-11, 12, 13, 14, 15, 16	Post Hole Diggers	O-2
Bell Hanger	K-2	Rust-Oleum Accessories	T-17	Power Tool Accessories	K-4, 5, 6, 13
Carbide Masonry	K-9	Rust-Oleum® NeverWet®	T-18	Rakes	O-2
Concrete Screw Accessory	I-4	Rust-Oleum® LeakSeal®	T-18	Setting Tool, Anchor	I-5
Electricians Power Bits	K-7	Perforated Iron Strap	F-4	Shovels	O-1
Hi-Speed Twist Fractional	K-1	Pigtailed, Grounding	J-1	Step Bits, Multi Cone	K-18
Hi-Speed Twist Numbered	K-1	Plastic Cable Straps Nail-In	J-3	Tamper-Proof Bits	K-15
S.D.S. Hammer Drills	K-9	Plastic Wall Anchors	I-1, 2, 3	Tape Measurers	O-3
Pilot Hole Saw	K-11	Rags - Bags/Boxes	K-16	Vests, Safety	M-2
Ship Auger	K-7	Ratchet Tie Down	K-16	Wall Dog	I-2
Wood Boring Spade Type	K-8	Rod Couplings, Hex	F-5	Washers	
Wood Drills	K-13	Saw Blades - Reciprocating, Hack	K-12	Belleville, Stainless	C-2
Drive, Hand Tools	F-5	Screw Eyes	F-3	Fender, Steel, Stainless Steel	C-2
Drive Pins, Concrete, 1/4" Hand Drive	F-5	Screw Hooks	F-3	Flat, Silicon Bronze	C-1
Driver, Hanger Bolt	F-2	Screws		Flat, Steel	C-1, 2
Duct Seal	Q-1	Concrete	I-4	Flat, Stainless	C-1
Dust Masks	K-16	Drywall	E-1, 2, 3	Reducing	C-3
Eye Bolts - Machine Type	F-3	Eye, Lag Type	F-3	Split Lock, Silicon Bronze	C-1
Eye Couplings	F-3	Flat Head, Machine	A-2	Split Lock, Stainless	C-1
Eye Screw, Lag Type	F-3	Flat Head, Self Tapping	D-5	Split Lock, Steel	C-1
Expansion Shields, Double	I-8			Work Gloves	L-1, 2, 3, 4

All specifications and dimensions are for reference only. If specific information is needed and/or of critical nature, contact Selecta Products headquarters for specific information before ordering.

©2014 SELECTA PRODUCTS, INC.

"SELECTA" is a registered trademark (Marca Registrada, "Marque Déposée") of Selecta Products, Inc. a California corporation.



CATALOG NUMBER NUMERIC INDEX

CATALOG NUMBER	PAGE NUMBER	CATALOG NUMBER	PAGE NUMBER	CATALOG NUMBER	PAGE NUMBER	CATALOG NUMBER	PAGE NUMBER	CATALOG NUMBER	PAGE NUMBER	CATALOG NUMBER	PAGE NUMBER	CATALOG NUMBER	PAGE NUMBER
14050	S-1	1680830	T-12	AKRHC1420	A-4, I-9	BRH634J	A-3	CSH145J	I-4	DW6158J	E-1		
14051	S-1	1681830	T-12	AKRHC832	A-4, I-9	BRH8112J	A-3	CSH316114J	I-4	DW6158B	E-1		
14077	K-17, S-2	1685830	T-13	AKSAE	C-3, I-9	BRH81J	A-3	CSH316134J	I-4	DW6158MJ	E-1		
18412	S-1	1686830	T-11	AKTKH810	D-4, I-9	BRH82J	A-3	CSH316214J	I-4	DW62J	E-1		
18414	S-2	1690830	T-11	AKTKP810	D-4, I-9	BRH834J	A-3	CSH316234J	I-4	DW62B	E-1		
		1692830	T-11	AKTKSQ810	D-4, I-9	BS1	J-1	CSH316314J	I-4	DW62M	E-1		
201516	T-15			AL14J	F-2			CSH316334J	I-4	DW6214J	E-1		
202214	T-11	1801838	T-16	ALDTSJ	F-2	C		CSH3164J	I-4	DW6214B	E-1		
203022	T-15	1834838	T-16			CB12212J	H-4	CSHK-1	I-4	DW6214MJ	E-1		
203023	T-15	1861838	T-16			CB122J	H-4	CSIT1000	I-4	DW8212J	E-1		
203024	T-15	1862838	T-16			CB123J	H-4			DW8212B	E-1		
203025	T-15	1868838	T-16			CB14112J	H-4	CSMHD14	I-4	DW8212MJ	E-1		
203026	T-15	1869838	T-16			CB1412J	H-4	CSMHD516	I-4	DW83J	E-1		
203027	T-15	1875838	T-16			CB141J	H-4	CSPHH2-3	I-4	DW83B	E-1		
203028	T-15	2242838	T-8	B		CB142J	H-4			DW83MJ	E-1		
203029	T-15	2255838	T-8	BC-3	K-16	CB1434J	H-4	CTT-1	G-2	DWG61J	E-1		
203030	T-15	2264838	T-8	BC-6	K-16	CB143J	H-4			DWG61B	E-1		
203031	T-16	2388000	T-17	BCS100	J-3	CB143J	H-4	D		DWG61MJ	E-1		
203031	T-16	2388000	T-17	BCS40	J-3	CB38112J	H-4	DAB10	K-6	DWG6114J	E-1		
203032	T-16	2395000	T-17	BHD1213	K-2	CB381J	H-4			DWG6114B	E-1		
203033	T-16			BHD1218	K-2	CB38212J	H-4	DES14J	I-8	DWG6114MJ	E-1		
203034	T-16	250-PB1	K-4	BHD1224	K-2	CB382J	H-4	DES516J	I-8	DWG6158J	E-1		
203035	T-16	250-PB2	K-4	BHD1418	K-2	CB3834J	H-4	DES538J	I-8	DWG6158B	E-1		
203036	T-16	250-PB3	K-4	BHD1424	K-2	CB383J	H-4	DES12J	I-8	DWG6158MJ	E-1		
203037	T-16	250-SQ1	K-4	BHD3813	K-2	CB384J	H-4			DWG62J	E-1		
203038	T-16	250-SQ2	K-4	BHD3818	K-2	CC12BJ	G-2	DLC3	F-4	DWG62B	E-1		
203039	T-16	250-SQ3	K-4	BHD3824	K-2	CC12J	G-2	DLC3R	F-4	DWG62MJ	E-1		
205176	T-16	300-PB1	K-4	BHD51613	K-2	CC148J	G-2	DLC3SS	F-4	DWG6214J	E-1		
206346	T-17	300-PB2	K-4	BHD51618	K-2	CC14J	G-2	DP34J	F-5	DWG6214B	E-1		
209567	T-7	300-PB3	K-4	BHD51624	K-2	CC18BJ	G-2	DP1J	F-5	DWG624MJ	E-1		
209715	T-8	30-PB1	K-4	BHDK1413	K-2	CC18J	G-2	DP114J	F-5	DWG8212J	E-1		
210188	T-17	30-PB2	K-4	BN1024J	B-1	CC38BJ	G-2	DP112J	F-5	DWG8212B	E-1		
215634	T-10	30-PB3	K-4	BN1032J	B-1	CC38J	G-2	DP2J	F-5	DWG8212MJ	E-1		
239007	T-15	30-SQ1	K-4	BN1213J	B-1	CCN112J	G-2	DP212J	F-5	DWG83J	E-1		
241526	T-13,17	30-SQ2	K-4	BN1420J	B-1	CCN14J	G-2			DWG83B	E-1		
243546	T-13,17	30-SQ3	K-4	BN3816J	B-1	CCN1316J	G-2	DS612J	D-3	DWG83MJ	E-1		
261937	T-13	420-1	K-7	BN51618J	B-1	CCN138J	G-2	DS614J	D-3				
264692	T-14	420-1116	K-7	BNG62J	B-1	CCN1516J	G-2	DS6112J	D-3	E			
264693	T-14	420-112	K-7	BN832J	B-1	CCN532J	G-2	DS6112J	D-3	EB102J	F-3		
264694	T-14	420-114	K-7	BOR-16	K-16			DS812J	D-3	EB1210	F-3		
264695	T-14	420-118	K-7	BOR-25	K-16	CDS5J	J-4	DS834J	D-3	EB1212	F-3		
264696	T-14	420-12	K-7	BOR-50	K-16	CDS4J	J-4	DS81J	D-3	EB126J	F-3		
264697	T-14	420-1316	K-7	BPDEPB	K-5	CDS6J	J-4	DS8114J	D-3	EB128J	F-3		
264699	T-14	420-138	K-7	BPDEPBPS	K-5	CG101	K-13	DS8112J	D-3	EB14212J	F-3		
264700	T-14	420-1516	K-7	BPDSC14-2	K-5			DS82J	D-3	EB14212J	F-3		
264702	T-14	420-34	K-7	BPDSC14L-2	K-5	CMD316-312	I-4	DS1012J	D-3	EB14212J	F-3		
266784	T-18	420-58	K-7	BPDSC38-2	K-5	CMD316-412	I-4	DS1034J	D-3	EB14312J	F-3		
267453	T-18	420-78	K-7	BPDSC38L-2	K-5	CMD316-512	I-4	DS101J	D-3	EB14312J	F-3		
268476	T-17	420-916	K-7	BPDSC38L-2	K-5	CMD316-612	I-4	DS10114J	D-3	EB14312J	F-3		
275185	T-18			BPDSC516-2	K-5	CMD532-312	I-4	DS10112J	D-3	EB144J	F-3		
				BPDSC516L-2	K-5	CMD532-412	I-4	DS1012J	D-3	EB382J	F-3		
1601838	T-15	520-1	K-7	BPMBHN14	K-5	CMD532-512	I-4	DS102J	D-3	EB384J	F-3		
1610830	T-11	520-1116	K-7			CP12	K-16	DS10212J	D-3	EB385J	F-3		
1614830	T-11	520-112	K-7	BPP1B1	K-5			DS103J	D-3	EB386J	F-3		
1622830	T-11	520-114	K-7	BPP1B2	K-5	CS100J	J-3	DS1212J	D-3				
1624830	T-12	520-118	K-7	BPP1B3	K-5	CS300J	J-3	DS1234J	D-3	EC1420J	F-3		
1626830	T-11	520-12	K-7	BPPP1B1	K-5	CS350J	J-3	DS121J	D-3				
1632830	T-12	520-1316	K-7	BPPP1B2	K-5	CS40J	J-3	DS12114J	D-3	EPB1	K-7		
1633830	T-12	520-138	K-7	BPSIB1012	K-5	CSF14114	I-4	DS12112J	D-3	EPB1116	K-7		
1634838	T-15	520-1516	K-7	BPSIB68	K-5	CSF14134	I-4	DS122J	D-3	EPB114	K-7		
1638830	T-11	520-34	K-7	BPSIB810	K-5	CSF14214	I-4	DS12212J	D-3	EPB118	K-7		
1642830	T-12	520-58	K-7	BPSIB810	K-5	CSF14214	I-4	DS123J	D-3	EPB1316	K-7		
1644830	T-12	520-78	K-7	BSPPB810	K-5	CSF14234	I-4	DS1434J	D-3	EPB34	K-7		
1653830	T-12	520-916	K-7	BPSQB2	K-5	CSF14314	I-4	DS141J	D-3	EPB58	K-7		
1654830	T-12			BRH10112J	A-3	CSF144	I-4	DS14114J	D-3	EPB78	K-7		
1655830	T-12	600-PB1	K-4	BRH101J	A-3	CSF145	I-4	DS14112J	D-3	EZT82J	I-3		
1659830	T-12	600-PB2	K-4	BRH102J	A-3	CSF316114	I-4	DS142J	D-3	EZT82K	I-3		
1660830	T-12	600-PB3	K-4	BRH1034J	A-3	CSF316134	I-4			EZT82KJ	I-3		
1661838	T-15	A		BRH112J	A-3	CSF316134	I-4	DSC14	K-4				
1662838	T-15	ABE12	K-7	BRH1112J	A-3	CSF316214	I-4	DSC14L	K-4	F			
1664830	T-11	ABE18	K-7	BRH11J	A-3	CSF316234	I-4	DSC516	K-4	F143J	F-1		
1666830	T-11	AKHN	B-2, I-9	BRH12J	A-3	CSF316314	I-4	DSC516L	K-4	F144J	F-1		
1667830	T-12	AKHWS10	D-6, I-9	BRH134J	A-3	CSF31634	I-4	DSC38L	K-4	F182J	F-1		
1669838	T-15	AKHWS8	D-6, I-9	BRH14112J	A-3	CSH14114J	I-4			F183J	F-1		
1670830	T-12	AKLW	C-3, I-9	BRH1412J	A-3	CSH14134J	I-4	DW61J	E-1	F184J	F-1		
1672830	T-11	AKPC10	D-6, I-9	BRH141J	A-3	CSH14214J	I-4	DW61B	E-1				
1674830	T-11	AKPC8	D-6, I-9	BRH142J	A-3	CSH14234J	I-4	DW61MJ	E-1				
1675838	T-15	AKPSQ8	D-6, I-9	BRH1434J	A-3	CSH14314J	I-4	DW6114B	E-1				
1676830	T-11	AKPSQ10	D-6, I-9	BRH6112J	A-3	CSH14334J	I-4	DW6114MJ	E-1				
1678830	T-11	AKPSQ8	D-6, I-9	BRH611J	A-3	CSH144J	I-4			F3163J	F-1		
1679830	T-11	AKRHC1032	A-4, I-9	BRH62J	A-3					F3164J	F-1		



CATALOG NUMBER NUMERIC INDEX

CATALOG NUMBER	PAGE NUMBER	CATALOG NUMBER	PAGE NUMBER	CATALOG NUMBER	PAGE NUMBER	CATALOG NUMBER	PAGE NUMBER	CATALOG NUMBER	PAGE NUMBER	CATALOG NUMBER	PAGE NUMBER
FCS100J	J-3	FW316114J	C-2	HDA141J	I-6	HSB1218	K-12	LB38212J	H-3	MCC78-138	K-18
FCS40J	J-3	FW3161J	C-2	HDA142J	I-6	HSB1224	K-12	LB382J	H-3	MD12	K-9
FFH1	F-4	FW38112J	C-2	HDA1434J	I-6	HSB1232	K-12	LB38312J	H-3	MD122	K-9
FFH2	F-4	FW38114J	C-2	HDA316J	I-6	HSDS7	K-3	LB383J	H-3	MD124	K-9
FH1112J	A-2	FW381J	C-2	HDT-10	F-5	HSF-1	K-12	LB38412J	H-3	MD126	K-9
FH1114J	A-2	FW382J	C-2	HDWA12234J	I-7	HSF-1	K-12	LB384J	H-3	MD126	K-9
FH112J	A-2	FW516112J	C-2	HDWA12312J	I-7	HSIB-18	K-15	LB38512J	H-3	MD142	K-9
FH11J	A-2	FW516114J	C-2	HDWA12434J	I-7	HSIB-532	K-15	LB385J	H-3	MD144	K-9
FH12J	A-2			HDWA12434J	I-7	HSKE	K-11	LB386J	H-3	MD146	K-9
FH134J	A-2			HDWA126	I-7	HSKM	K-11	LB516112J	H-3	MD16	K-9
FH14112J	A-2			HDWA14134J	I-7	HSKME	K-11	LB516114J	H-3	MD3164	K-9
FH14114J	A-2			HDWA14238J	I-7	HSKP	K-11	LB516134J	H-3	MD342	K-9
FH1412J	A-2			HDWA345	I-7	HSPB14F	K-11	LB5161J	H-3	MD346	K-9
FH141J	A-2			HDWA346	I-7	HSPB14S	K-11	LB516212J	H-3	MD382	K-9
FH141J	A-2			HDWA38238J	I-7	HWA14LJ	F-2	LB5162J	H-3	MD384	K-9
FH14212J	A-2			HDWA38312J	I-7	HWA14SJ	F-2	LB516312J	H-3	MD386	K-9
FH142J	A-2			HDWA385J	I-7	HWA14XLJ	F-2	LB5163J	H-3	MD5162	K-9
FH1434J	A-2			HDWA516234J	I-7	HWA18LJ	F-2	LB516412J	H-3	MD5164	K-9
FH143J	A-2			HDWA5162J	I-7	HWA18SJ	F-2	LB5164J	H-3	MD5166	K-9
FH6112J	A-2			HDWA5164J	I-7	HWA18XLJ	F-2	LB5165J	H-3	MD582	K-9
FH6114J	A-2			HDWA58434	I-7	HWA18XSJ	F-2	LB5166J	H-3	MD586	K-9
FH612J	A-2			HDWA584	I-7	HWA316LJ	F-2	LN1024J	B-2	MD7166	K-9
FH6134J	A-2			HDWA586J	I-7	HWA316SJ	F-2	LN1032J	B-2	MD782	K-9
FH61J	A-2			HMA1420J	F-6	HWA316SJ	F-2	LN1213J	B-2	MD786	K-9
FH6212J	A-2			HMA1420WJ	F-6	HWA316XLJ	F-2	LN1213J	B-2	MD9166	K-9
FH62J	A-2			HMA3816J	F-6	HWD18LJ	F-2	LN1420J	B-2	MS6114J	J-4
FH634J	A-2			HMA3816WJ	F-6	ICS40B	J-3	LN3816J	B-2	MS612J	J-4
FH63J	A-2			HMA1420SMJ	F-6	ICS40FJ	J-3	LN51618J	B-2	MS61J	J-4
FH64J	A-2			HMA1420SMWJ	F-6	ICS40J	J-3	LN632J	B-2	MS634J	J-4
FH8112J	A-2			HMA3816SMJ	F-6	IFS12	K-17	LN832J	B-2	MS8112J	J-4
FH8114J	A-2			HMA3816SMWJ	F-6	IFS24	K-17	LSA	F-2	MS8114J	J-4
FH812J	A-2			HMDB-5/8	F-6	IS10J	J-3	LSS123J	H-4	MS81J	J-4
FH81J	A-2			HPAK14	I-1	IS1J	J-3	LSS14112J	H-4	MS834J	J-4
FH8212J	A-2			HPAK14J	I-1	IS3J	J-3	LSS38212J	H-4	MSA102J	I-5
FH82J	A-2			HPAK316	I-1	IS5J	J-3	LSS516134J	H-4	MSA12J	I-5
FH834J	A-2			HPAK316J	I-1	IS6J	J-3	LSS516114J	H-4	MSA14J	I-5
FH83J	A-2			HPAK516	I-1	IS7J	J-3	LSS516114J	H-4	MSA38J	I-5
FS10112J	E-3			HPAK516J	I-1	JAC10	F-4	LSS516114J	H-4	MSA516J	I-5
FS10114J	E-3			HS1	K-10	JAC10CBSS	F-4	LW10J	C-1	MSA6J	I-5
FS10134J	E-3			HS1116	K-10	JAC12	F-4	LW12J	C-1	MSA8J	I-5
FS101J	E-3			HS112	K-10	JAC12C	F-4	LW14J	C-1	MSD8	K-15
FS10212J	E-3			HS114	K-10	JAC12CB	F-4	LW21J	C-1	MSK50DS	K-16
FS10214J	E-3			HS118	K-10	JAC12F	F-4	LW38J	C-1	MSK50SS	K-16
FS102J	E-3			HS1316	K-10	JAC12SS	F-4	LW516J	C-1	MSK55S	K-16
FS1034J	E-3			HS1316	K-10	LB12212J	H-3	LW6J	C-1	MST102	I-5
FS103J	E-3			HS134	K-10	LB122J	H-3	LW8J	C-1	MST12	I-5
FS12112J	E-3			HS138	K-10	LB12312J	H-3	LWSA1014112J	I-8	MST14	I-5
FS12114J	E-3			HS1516	K-10	LB123J	H-3	LWSA10141J	I-8	MST14	I-5
FS12212J	E-3			HS1516	K-10	LB12412J	H-3	LWSA101434J	I-8	MST38	I-5
FS122J	E-3			HS158	K-10	LB124J	H-3	LWSA10148112J	I-8	MST516	I-5
FS123J	E-3			HS178	K-10	LB12512J	H-3	LWSA1618112J	I-8	MST6	I-5
FS14212J	E-3			HS2	K-10	LB125J	H-3	LWSA16181J	I-8	MST8	I-5
FS142J	E-3			HS212	K-10	LB126J	H-3	LWSA68112J	I-8	MX14J	I-1
FS4114J	E-3			HS214	K-10	LB14112J	H-3	LWSA681J	I-8	MX316J	I-1
FS412J	E-3			HS218	K-10	LB14114J	H-3	LWSA6834J	I-8	MX516J	I-1
FS41J	E-3			HS238	K-10	LB14134J	H-3				
FS434J	E-3			HS2516	K-10	LB141J	H-3				
FS51J	E-3			HS2916	K-10	LB14212J	H-3				
FS534J	E-3			HS3	K-10	LB142J	H-3				
FS6112J	E-3			HS312	K-10	LB14312J	H-3				
FS6114J	E-3			HS34	K-10	LB143J	H-3				
FS612J	E-3			HS358	K-10	LB14412J	H-3				
FS61J	E-3			HS4	K-10	LB144J	H-3				
FS62J	E-3			HS412	K-10	LB145J	H-3				
FS634J	E-3			HS414	K-10	LB146J	H-3				
FS8112J	E-3			HS418	K-10	LB38112J	H-3				
FS8114J	E-3			HS434	K-10	LB38114J	H-3				
FS8134J	E-3			HS5	K-10	LB3812J	H-3				
FS81J	E-3			HS512	K-10	LB38134J	H-3				
FS8212J	E-3			HS58	K-10	LB381J	H-3				
FS82J	E-3			HS6	K-10						
FS834J	E-3			HS78	K-10						
FS83J	E-3			HS916	K-10						
FW12112J	C-2			HSA14R	K-11						
FW122J	C-2			HSA38H	K-11						
FW14112J	C-2			HSA716H	K-11						
FW14114J	C-2			HSA716HH	K-11						
FW141J	C-2										
FW142J	C-2										

CATALOG NUMBER NUMERIC INDEX

CATALOG NUMBER	PAGE NUMBER	CATALOG NUMBER	PAGE NUMBER	CATALOG NUMBER	PAGE NUMBER	CATALOG NUMBER	PAGE NUMBER	CATALOG NUMBER	PAGE NUMBER	CATALOG NUMBER	PAGE NUMBER
NSP6BRJ	J-2	R182J	F-1	RH3834J	A-1	SBHCS12112J	H-2	SDSHB3418	K-9	SLW38J	C-1
NSP6J	J-2	R183J	F-1	RH383J	A-1	SBHCS12114J	H-2	SDSHB348	K-9	SLW516J	C-1
NSP6WJ	J-2	R184J	F-1	RH384J	A-1	SBHCS121J	H-2	SDSHB3812	K-9	SLW6J	C-1
O		R3162J	F-1	RH5161J	A-1	SBHCS12212J	H-2	SDSHB3818	K-9	SLW8J	C-1
OWRDT-10	K-15	R3163J	F-1	RH6112J	A-1	SBHCS122J	H-2	SDSHB386	K-9	SN1J	I-3
OWRDT-14	K-15	R3164J	F-1	RH6114J	A-1	SBHCS123J	H-2	SDSHB5166	K-9	SN1K	I-3
OWRDT-6	K-15	R3165J	F-1	RH612J	A-1	SBHCS14112J	H-2	SDSHB5812	K-9	SN1KJ	I-3
OWRDT-8	K-15	R3166J	F-1	RH614J	A-1	SBHCS14114J	H-2	SDSHB5818	K-9	SN2ZJ	I-3
P		R383J	F-1	RH61J	A-1	SBHCS1412J	H-2	SDSHB588	K-9	SN2ZK	I-3
PAK14	I-1	R384J	F-1	RH6212J	A-1	SBHCS141J	H-2	SDSHB7169	K-9	SN2ZKJ	I-3
PAK14J	I-1	R385J	F-1	RH62J	A-1	SBHCS1434J	H-2	SDSHB7810	K-9	SN2ZLJ	I-3
PAK14L	I-1	R386J	F-1	RH634J	A-1	SBHCS38112J	H-2	SDSHB9169	K-9	SN2ZLK	I-3
PAK14LJ	I-1	R5163J	F-1	RH638J	A-1	SBHCS38114J	H-2	SDSW12	K-5	SN2ZLKJ	I-3
PAK14PF	I-2	R5164J	F-1	RH63J	A-1	SBHCS381J	H-2	SE11516J	F-3	SNL1J	I-3
PAK14RJ	I-2	R5165J	F-1	RH8112J	A-1	SBHCS382J	H-2	SE1516J	F-3	SNL1K	I-3
PAK316	I-1	R5166J	F-1	RH8114J	A-1	SBHCS3834J	H-2	SE2316J	F-3	SNL1KJ	I-3
PAK316J	I-1	R8CCRF	K-12	RH812J	A-1	SBHCS5161J	H-2	SE258J	F-3	SP612TPSPJ	J-2
PAK316RJ	I-2	RB1218HDM	K-12	RH81J	A-1	SBLW12J	C-1	SE514J	F-3	SP61BJ	J-2
PAK516	I-1	RB125W	K-12	RH8212J	A-1	SBLW14J	C-1	SE8	F-3	SP61JJ	J-2
PAK516J	I-1	RB414	K-12	RH82J	A-1	SBLW38J	C-1	SFW12112J	C-2	SP615SJ	J-2
PAK516RJ	I-2	RB414M	K-12	RH834J	A-1	SBLW516J	C-1	SFW122J	C-2	SP61WJ	J-2
PCDS2J	J-4	RB424M	K-12	RH83J	A-1	SBN1213J	B-1	SFW14112J	C-2	SP62J	J-2
PCDS4J	J-4	RB610HDM	K-12	RNA1415J	I-6	SBN1420J	B-1	SFW14114J	C-2	SP625SJ	J-2
PCDS6J	J-4	RB614HDM	K-12	RNA141J	I-6	SBN3816J	B-1	SFW141J	C-2	SP62WJ	J-2
PCSNI12J	J-3	RB624HDM	K-12	RNA31615J	I-6	SBW12J	C-1	SFW38112J	C-2	SP634BJ	J-2
PCSNI34J	J-3	RB636DW	K-12	RNA3161J	I-6	SBW14J	C-1	SFW38114J	C-2	SP634J	J-2
PDW6716	E-2	RB636W	K-12	RSB14112J	A-2	SBW38J	C-1	SG-21GB79	M-4	SP6345SJ	J-2
PDW6716B	E-2	RB656WS	K-12	RSB14114J	A-2	SBW516J	C-1	SG-21GB78	M-4	SP634WJ	J-2
PDW6716M	E-2	RB810HDM	K-12	RSB141J	A-2	SC6114B	E-2	SG-28GB80	M-3	SP6BNJ	J-2
PSC6716B	E-2	RB814HDM	K-12	RSB142J	A-2	SC6114J	E-2	SG-28GB83	M-3	SP6BRJ	J-2
PSC6716MJ	E-2	RB956W	K-12	RSB1434J	A-2	SC6114MJ	E-2	SG-28CM5M	M-3	SP62ALJ	J-2
PSI34	F-4	RBS1412J	A-2	RSB1438J	A-2	SC6158B	E-2	SG-4680	M-3	SP6J	J-2
PT12	J-1	RTD-1	K-16	RTD-1	K-16	SC6158J	E-2	SG-4480	M-3	SP6NJ	J-2
PT14	J-1	RW112114J	C-3	RW11212J	C-3	SC6158MJ	E-2	SG-4483	M-3	SP6SSJ	J-2
PTA12J	I-3	RW11212J	C-3	RW1121J	C-3	SC61B	E-2	SG-45079	M-4	SP6WJ	J-2
PTA38J	I-3	RW11234J	C-3	RW1141J	C-3	SC61J	E-2	SGOG1	K-16, M-4	SP-BSC-L	L-4
PTA58J	I-3	RW11412J	C-3	RW1141J	C-3	SC61MJ	E-2	SH2116J	F-3	SP-BSC-XL	L-4
PTAK12J	I-3	RW11434J	C-3	RW11412J	C-3	SC8258B	E-2	SH32916J	F-3	SP-BT100	N-3
PTAK38J	I-3	RW2112J	C-3	RW2114J	C-3	SC8258MJ	E-2	SH338J	F-3	SP-BT105	N-3
PTAK58J	I-3	RW2114J	C-3	RW212J	C-3	SC83B	E-2	SH418J	F-3	SP-BT110	N-3
PTB12	J-1	RW2212J	C-3	RW221J	C-3	SC83J	E-2	SHCS12112J	H-2	SP-BT115	N-3
PTB14	J-1	RW234J	C-3	RW234J	C-3	SC83MJ	E-2	SHCS12114J	H-2	SP-BT120	N-3
PTS12	J-1	RW34212J	C-3	RW34212J	C-3	SC83MJ	E-2	SHCS121J	H-2	SP-BT125	N-3
PTS14	J-1	SA12214J	I-6	SA12214J	I-6	SC83MJ	E-2	SHCS12212J	H-2	SP-BT130	N-3
Q		SA123J	I-6	SA123J	I-6	SC83MJ	E-2	SHCS122J	H-2	SP-BT135	N-3
QD101-1/4J	D-3	SA14138J	I-6	SA14138J	I-6	SC83MJ	E-2	SHCS1234J	H-2	SP-BT140	N-3
QD10112-1/4J	D-3	SA14214J	I-6	SA14214J	I-6	SC83MJ	E-2	SHCS14112J	H-2	SP-BT140	N-3
QD10112-5/16J	D-3	SA34212J	I-6	SA34212J	I-6	SC83MJ	E-2	SHCS14114J	H-2	SP-BT200	N-3
QD1012-1/4J	D-3	SA34414J	I-6	SA34414J	I-6	SC83MJ	E-2	SHCS1412J	H-2	SP-BT205	N-3
QD1012-5/16J	D-3	SA34614J	I-6	SA34614J	I-6	SC83MJ	E-2	SHCS141J	H-2	SP-BT210	N-3
QD101-5/16J	D-3	SA38178J	I-6	SA38178J	I-6	SC83MJ	E-2	SHCS142J	H-2	SP-DSP130	O-1
QD102-1/4J	D-3	SA383J	I-6	SA383J	I-6	SC83MJ	E-2	SHCS142J	H-2	SP-DSP135	O-1
QD102-5/16J	D-3	SA51612J	I-6	SA51612J	I-6	SC83MJ	E-2	SHCS1434J	H-2	SP-DS1P	Q-1
QD1034-1/4J	D-3	SA516212J	I-6	SA516212J	I-6	SC83MJ	E-2	SHCS1434J	H-2	SP-D55P	Q-1
QD1034-5/16J	D-3	SA58214J	I-6	SA58214J	I-6	SC83MJ	E-2	SHCS38112J	H-2	SP-DT300	N-6
QD712-1/4J	D-3	SA58414J	I-6	SA58414J	I-6	SC83MJ	E-2	SHCS38114J	H-2	SP-DT305	N-6
QD81-1/4J	D-3	SA58534J	I-6	SA58534J	I-6	SC83MJ	E-2	SHCS3812J	H-2	SP-DT310	N-6
QD812-1/4J	D-3	SAE10J	C-1	SAE10J	C-1	SC83MJ	E-2	SHCS381J	H-2	SP-DT315	N-6
QD82-1/4J	D-3	SAE12J	C-1	SAE12J	C-1	SC83MJ	E-2	SHCS382J	H-2	SP-DT320	N-6
QD834-1/4J	D-3	SAE14J	C-1	SAE14J	C-1	SC83MJ	E-2	SHCS3834J	H-2	SP-DT600	N-7
R		SAE34J	C-1	SAE34J	C-1	SC83MJ	E-2	SHCS38114J	H-2	SP-DT605	N-7
R124J	F-1	SAE38J	C-1	SAE38J	C-1	SC83MJ	E-2	SHCS382J	H-2	SP-DT610	N-7
R125J	F-1	SAE516J	C-1	SAE516J	C-1	SC83MJ	E-2	SHCS3834J	H-2	SP-DT615	N-7
R126J	F-1	SAE58J	C-1	SAE58J	C-1	SC83MJ	E-2	SHN1024J	B-1	SP-DT620	N-7
R143J	F-1	SAE6J	C-1	SAE6J	C-1	SC83MJ	E-2	SHN1032J	B-1	SP-DT-BLK	N-2
R144J	F-1	SAE8J	C-1	SAE8J	C-1	SC83MJ	E-2	SHN1213J	B-1	SP-DT-BLU	N-2
R145J	F-1	SBE12	K-8	SBE12	K-8	SC83MJ	E-2	SHN1420J	B-1	SP-DT-GRN	N-2
R146J	F-1					SC83MJ	E-2	SHN51618J	B-1	SP-DT-RED	N-2
						SC83MJ	E-2	SHN632J	B-1	SP-DT-SLV	N-2
						SC83MJ	E-2	SHN832J	B-1	SP-DT-YLW	N-2
						SC83MJ	E-2	SK112J	F-4	SP-EH105	O-3
						SC83MJ	E-2	SK114J	F-4	SP-ET-BLK	N-1
						SC83MJ	E-2	SK78J	F-4	SP-ET-BLU	N-1
						SC83MJ	E-2	SLW10J	C-1		
						SC83MJ	E-2	SLW12J	C-1		
						SC83MJ	E-2	SLW14J	C-1		

Items in green have been discontinued. Please contact Selecta for details.



CATALOG NUMBER NUMERIC INDEX

CATALOG NUMBER	PAGE NUMBER	CATALOG NUMBER	PAGE NUMBER	CATALOG NUMBER	PAGE NUMBER	CATALOG NUMBER	PAGE NUMBER	CATALOG NUMBER	PAGE NUMBER	CATALOG NUMBER	PAGE NUMBER
SP-ET-BRN	N-1	SP-KOSBT12J	R-2	SRH1034J	A-3	TD1564	K-1	TIE15B	G-1	TR12	F-5
SP-ET-GRN	N-1	SP-KOSBT1J	R-2	SRH1112J	A-3	TD1564A	K-1	TIE15BM	G-1	TR14	F-5
SP-ET-GRY	N-1	SP-KOSBT212	R-2	SRH11J	A-3	TD1764	K-1	TIE15EHD	G-1	TR34	F-5
SP-ET-ORG	N-1	SP-KOSBT2J	R-2	SRH12J	A-3	TD1764A	K-1	TIE15M	G-1	TR38	F-5
SP-ET-PRL	N-1	SP-KOSBT312	R-2	SRH134J	A-3	TD18	K-1	TIE15TB	G-1	TR516	F-5
SP-ET-RED	N-1	SP-KOSBT34J	R-2	SRH14112J	A-3	TD18A	K-1	TIE16LHDB	G-1	TS10112J	D-1
SP-ET-WHT	N-1	SP-KOSBT3	R-2	SRH1412J	A-3	TD1964	K-1	TIE16TB	G-1	TS10114J	D-1
SP-ET-YLW	N-1	SP-KOSBT4	R-2	SRH141J	A-3	TD1964A	K-1	TIE21EHD	G-1	TS1012J	D-1
SP-FPM	P-1	SP-KOSBT5	R-2	SRH142J	A-3	TD2164	K-1	TIE30EHD	G-1	TS101J	D-1
		SP-KOSBT6	R-2	SRH1434J	A-3	TD2164A	K-1	TIE4	G-1	TS10212J	D-1
SP-GL100	L-1	SP-KSM	P-1	SRH6112J	A-3	TD2364	K-1	TIE4B	G-1	TS102J	D-1
SP-GL100-J	L-1			SRH61J	A-3	TD2364A	K-1	TIE4BM	G-1	TS102J	D-1
SP-GL105	L-1	SP-LC-BLK	P-1	SRH62J	A-3	TD2564	K-1	TIE4M	G-1	TS1034J	D-1
SP-GL110	L-1	SP-LC-BLU	P-1	SRH634J	A-3	TD2564A	K-1	TIE4TB	G-1	TS1034J	D-1
SP-GL115	L-1			SRH8112J	A-3	TD2764	K-1	TIE5	G-1	TS103J	D-1
SP-GL120-L	L-1	SP-LCH	P-1	SRH81J	A-3	TD2764A	K-1	TIE5M	G-1	TS1058J	D-1
SP-GL120-M	L-1	SP-LC-RED	P-1	SRH82J	A-3	TD2964	K-1	TIE6	G-1	TS12112J	D-1
SP-GL120-XL	L-1	SP-LC-YLW	P-1	SRH834J	A-3	TD2964A	K-1	TIE6B	G-1	TS12114J	D-1
SP-GL125-L	L-1	SP-PHD140	O-2	SSAE10J	C-1	TD316	K-1	TIE6BM	G-1	TS1212J	D-1
SP-GL125-S	L-1			SSAE12J	C-1	TD316A	K-1	TIE6M	G-1	TS121J	D-1
SP-GL125-XL	L-1	SP-PK100	O-3	SSAE14J	C-1	TD3164A	K-1	TIE6TB	G-1	TS12212J	D-1
SP-GL130-L	L-1			SSAE38J	C-1	TD316A	K-1	TIE8	G-1	TS122J	D-1
SP-GL130-M	L-1	SP-RCT150	O-2	SSAE516J	C-1	TD332	K-1	TIE8B	G-1	TS1234J	D-1
SP-GL130-XL	L-1			SSAE6J	C-1	TD332A	K-1	TIE8BM	G-1	TS123J	D-1
SP-GL135-L	L-2	SP-SFT100	N-8	SSAE8J	C-1	TD38	K-1	TIE8M	G-1	TS14112J	D-1
SP-GL135-M	L-2	SP-SFT105	N-8	SSBW12J	C-2	TD38A	K-1	TIE8TB	G-1	TS14114J	D-1
SP-GL135-XL	L-2	SP-SFT110	N-8	SSBW12THKJ	C-2	TD38R	K-1	TK10112J	D-4	TS1412J	D-1
SP-GL140-L	L-2	SP-SFT115	N-8	STOP1	K-13	TD516	K-1	TK10114J	D-4	TS141J	D-1
SP-GL140-M	L-2	SP-SFT200	N-8	STOP2	K-13	TD516A	K-1	TK1012J	D-4	TS142J	D-1
SP-GL140-XL	L-2	SP-SFT205	N-8	STO2P	K-13	TD516R	K-1	TK101J	D-4	TS1434J	D-1
SP-GL145-L	L-2	SP-SFT210	N-8	STS10112J	D-2	TD532	K-1	TK102J	D-4	TS412J	D-1
SP-GL145-M	L-2	SP-SFT215	N-8	STS10114J	D-2	TD532A	K-1	TK1034J	D-4	TS41J	D-1
SP-GL145-XL	L-2			STS1012J	D-2	TD564	K-1	TK12112J	D-4	TS434J	D-1
SP-GL150-L	L-2	SP-SH110	O-3	STS1012J	D-2	TD564A	K-1	TK1212J	D-4	TS6112J	D-1
SP-GL150-M	L-2	SP-SH115	O-3	STS101J	D-2	TD716	K-1	TK12114J	D-4	TS6114J	D-1
SP-GL150-XL	L-2	SP-SH120	O-3	STS102J	D-2	TD716A	K-1	TK121J	D-4	TS612J	D-1
SP-GL155-L	L-2			STS1034J	D-2	TD716R	K-1	TK122J	D-4	TS614J	D-1
SP-GL155-M	L-2	SP-SRP100	O-1	STS1212J	D-2	TD732	K-1	TK1234J	D-4	TS61J	D-1
SP-GL155-XL	L-2	SP-SRP105	O-1	STS121J	D-2	TD732A	K-1	TK14112J	D-4	TS62J	D-1
SP-GL160-L	L-3	SP-SRP110	O-1	STS1234J	D-2	TD764	K-1	TK14114J	D-4	TS634J	D-1
SP-GL160-M	L-3			STS612J	D-2	TD764A	K-1	TK141J	D-4	TS638J	D-1
SP-GL160-XL	L-3	SP-SSP115	O-1	STS61J	D-2	TD932	K-1	TK1434J	D-4	TS8112J	D-1
SP-GL170-L	L-3	SP-SSP120	O-1	STS634J	D-2	TD932A	K-1	TK8112J	D-4	TS8114J	D-1
SP-GL170-M	L-3	SP-SSP125	O-1	STS8112J	D-2	TD964	K-1	TK8114J	D-4	TS812J	D-1
SP-GL170-XL	L-3	SP-SV1-L	M-2	STS8114J	D-2	TD964A	K-1	TK812J	D-4	TS81J	D-1
SP-GL175-L	L-3	SP-SV1-M	M-2	STS812J	D-2	TDBS13	K-3	TK81J	D-4	TS8212J	D-1
SP-GL175-M	L-3	SP-SV1-XL	M-2	STS81J	D-2	TDD210	K-3	TK834J	D-4	TS82J	D-1
SP-GL175-XL	L-3			STS82J	D-2	TDD210A	K-3	TKED12114J	D-6	TS834J	D-1
SP-GL180-L	L-4	SP-SV5-L	M-2	STS834J	D-2	TDDC329	K-3			TS838J	D-1
SP-GL180-M	L-4	SP-SV5-M	M-2								
SP-GL180-XL	L-4	SP-SV5-XL	M-2								
SP-GL185-L	L-4	SP-TM25	O-3	TAP1024	K-2	TDK1	K-3	TKP10112J	D-4	TSF10112J	D-5
SP-GL185-M	L-4	SP-TM33	O-3	TAP1032	K-2	TDK2	K-3	TKP10114J	D-4	TSF10114J	D-5
SP-GL185-XL	L-4	SP-UT300	N-4	TAP1213	K-2	TDK3	K-3	TKP101J	D-4	TSF101J	D-5
				TAP1420	K-2	TDK4	K-3	TKP102J	D-4	TSF102J	D-5
SP-HHUVR-BLU	M-1	SP-UT305	N-4	TAP3816	K-2	TDN10	K-2	TKP1034J	D-4	TSF1034J	D-5
SP-HHUVR-PNK	M-1	SP-UT310	N-4	TAP440	K-2	TDN11	K-2	TKP612J	D-4	TSF6112J	D-5
SP-HHUVR-WHT	M-1	SP-UT315	N-4	TAP51618	K-2	TDN20	K-2	TKP61J	D-4	TSF6114J	D-5
SP-HHUVR-YLW	M-1	SP-UT320	N-4	TAP632	K-2	TDN21	K-2	TKP638J	D-4	TSF612J	D-5
		SP-UT325	N-4	TAP832	K-2	TDN22	K-2	TKP812J	D-4	TSF61J	D-5
SP-HHVR-BLU	M-1	SP-UT330	N-4	TKB20	K-6	TDN25	K-2	TKP834J	D-4	TSF62J	D-5
SP-HHVR-PNK	M-1	SP-UT335	N-4	TBK30	K-6	TDN26	K-2	TKSD10112J	D-5	TSF634J	D-5
SP-HHVR-WHT	M-1	SP-UT340	N-4	TD1132	K-1	TDN28	K-2	TKSD10114J	D-5	TSF8112J	D-5
SP-HHVR-YLW	M-1	SP-UT345	N-4	TD1132A	K-1	TDN29	K-2	TKSD1012J	D-5	TSF8114J	D-5
SPIB-10	K-15	SP-UT350	N-4	TD116	K-1	TDN30	K-2	TKSD101J	D-5	TSF812J	D-5
SPIB-12	K-15	SP-UT600	N-5	TD1164	K-1	TDN31	K-2	TKSD102J	D-5	TSF81J	D-5
SPIB-14	K-15	SP-UT605	N-5	TD1164A	K-1	TDN35	K-2	TKSD1034J	D-5	TSF82J	D-5
SPIB-6	K-15	SP-UT610	N-5	TD116A	K-1	TDN36	K-2	TKSD1058J	D-5	TSF834J	D-5
SPIB-8	K-15	SP-UT615	N-5	TD116A	K-1	TDN37	K-2	TKSD1081J	D-5	TSF881J	D-5
SPK1	I-9, J-2	SP-UT620	N-5	TD12	K-1	TDN43	K-2	TKSD812J	D-5	TSF82J	D-5
SPK2	I-9, J-2	SP-UT625	N-5	TD12A	K-1	TDN6	K-2	TKSD834J	D-5	TSF834J	D-5
SP-KOS112J	R-1	SP-UT630	N-5	TD12R	K-1	TDN7	K-2	TSIB-10	K-15	TSF8112J	D-5
SP-KOS114J	R-1	SP-UT635	N-5	TD1332	K-1	TDN8	K-2	TSIB-15	K-15	TKSD10114J	D-5
SP-KOS12J	R-1	SP-UT640	N-5	TD1332A	K-1	TDN9	K-2	TSIB-20	K-15	TKSD1012J	D-5
SP-KOS1J	R-1	SP-UT645	N-5	TD1364	K-1	TIE11	G-1	TSIB-25	K-15	TKSD101J	D-5
SP-KOS2J	R-1	SP-UT650	N-5	TD1364A	K-1	TIE11B	G-1	TSIB-27	K-15	TKSD102J	D-5
SP-KOS34J	R-1	SRH10112J	A-3	TD14	K-1	TIE11BM	G-1	TSIB-30	K-15	TKSD1034J	D-5
		SRH101J	A-3	TD14A	K-1	TIE11M	G-1	TN1024 J	B-2	TKSD1058J	D-5
SP-KOSBT112J	R-2	SRH102J	A-3	TD1532	K-1	TIE11TB	G-1	TN1032 J	B-2	TKSD812J	D-5
SP-KOSBT114J	R-2			TD1532A	K-1	TIE15	G-1	TN1420 J	B-2	TKSD834J	D-5
								TN3816J	B-2	TKSD881J	D-5
								TN51618 J	B-2	TSFSD834J	D-5
								TN632 J	B-2	TSIB-10	K-15
								TN832J	B-2	TSIB-15	K-15
								TPK29	K-15	TSIB-20	K-15
										TSIB-25	K-15
										TSIB-27	K-15
										TSIB-30	K-15
										TSS10112J	D-2
										TSS10114J	D-2
										TSS1012J	D-2



Items in green have been discontinued. Please contact Selecta for details.

DESCRIPTION ABRIDGEMENTS

ABE	Auger Bit Extension	HSB	Hack Saw Blade	SHN	Stainless Hex Nut
AKFH	Assortment Kit Flat Head M/S	HSDS	High Speed Drill Set	SK	S-Hook
AKHN	Assortment Kit Hex Nuts	HSF	Hack Saw Frame	SLW	Stainless Steel Lock Washer
AKHWS	Assortment Kit Hex Washer D/S	HSIB	Hex Security Insert Bit	SN	Screw-In Anchor
AKLW	Assortment Kit Lock Washers	HSKE	Hole Saw Kit Electricians	SNIK	Screw-In-Anchors Kit
AKPC	Assortment Kit Pan Combo SMS	HSKM	Hole Saw Kit Maintenance	SNL	Screw-In Anchor Light, Plastic
AKPS	Assortment Kit Pan Square SMS	HSKME	Hole Saw Kit Master Electrician	SN2Z	Screw-In Anchor Light, Zinc
AKRHC	Assortment Kit Round Head Combo M/S	HSKP	Hole Saw Kit Plumbers	SP	Switch Plate Screw
AKSAE	Assortment Kit SAE Flat Washer	HSPB	Hole Saw Pilot Bit	SP-	Selecta Products
AKTK	Assortment Kit Hex Tek Self Drilling	HWA	Hollow Wall Anchor	SP-BSC	Selecta Products Blue Shoe Cover
AKTKP	Assortment Kit Pan Self Drilling	HWD	Hollow Wall Drive Anchor	SP-BT	Selecta Products Barricade Tape
AKTKSQ	Assortment Kit Pan SQ Self Drilling	ICS	Insulated Cable Staple	SP-DP	Selecta Products Drain Spade
AL	Acoustical Lag Screw	IFS	Insulation Foam Sealant	SP-DS	Selecta Products Duct Seal
ATW	Tie Wire	IS	Insulated Staple	SP-DT	Selecta Products Duct Tape
BC	Bungee Cords	JAC	Jack Chain	SP-DT3	Selecta Products Detectable Tape 3 Inch
BCS	Bulk Cable Staple	LB	Lag Bolt	SP-DT6	Selecta Products Detectable Tape 6 Inch
BHD	Bell Hanger Drill	LN	Nylon Lock Nut	SP-EH	Selecta Products Engineer Hammer
BN	Brass Hex Nuts	LSA	Acoustical Lag Screw Drive Tool	SP-ET	Selecta Products Electrical Tape
BOR	Bag of Rags	LSL	Lag Screw Shield Long	SP-FPM	Selecta Products Fine Point Marker
BOR	Box of Rags	LSS	Lag Screw Shield Short	SP-GL	Selecta Products Gloves
BPDEBP	Blstr/Pak Double End Phil Bit	LW	Lock Washer	SP-HHVR	Selecta Products Hard Hat Unvented Ratchet
BPDEBPBS	Blstr/Pak Double End Phil/Slot Bit	LWSA	Lead Wood Screw Anchor	SP-HHVR	Selecta Products Hard Hat Vented Ratchet
BPDSC	Blstr/Pak Drill Screw Chuck	M	Mushroom Head Toggle Bolt	SP-KOS	Selecta Products Knockout Seals (Snap-In)
BPHSDS	Blstr/Pak Hex Socket Drill Set	MB	Mounting Brackets, Cable Tie	SP-KOSBT	Selecta Products Knockout Seals (Screw/) Bar Type
BPMBHN	Blstr/Pak Magnetic Bit Holder	MBHN	Magnetic Insert Bit Holder	SP-KSM	Selecta Products King Size Marker
BPPIB	Blstr/Pak Phillips Insert Bit	MCC	Multi Cone Cutter	SP-LC	Selecta Products Lumber Crayon
BPPPB	Blstr/Pak Phillips Power Bit	MD	Masonry Drill	SP-LCH	Selecta Products Lumber Crayon Holder
BPSIB	Blstr/Pak Slotted Insert Bit	MS	Mounting Screw	SP-PHD	Selecta Products Post Hole Digger
BPSPB	Blstr/Pak Slotted Power Bit	MSA	Machine Screw Anchor	SP-PK	Selecta Products Pick
BPSQIB	Blstr/Pak Square Insert Bit	MSDH	Magnetic Screwdriver Handle	SP-RCT	Selecta Products Rake Curved Tines
BRH	Brass Round Head Machine Screw	MSK	Mask, Dust	SP-RST	Selecta Products Rake Straight Tines
BS	Box Support	MST	Machine Screw Anchor Tool	SP-SFT	Selecta Products Self-Fusing Tape
CC	Cable Clips Nylon	MX	MXWall Anchor	SP-SH	Selecta Products Sledge Hammer
CCNI	Cable Clips Nail-In	MXK	MX Anchor Kit	SP-SRP	Selecta Products Shovel Round Point
CDSC	Conduit Drive Strap Copper	N	Nuts	SP-SSP	Selecta Products Shovel Square Point
CDS	Conduit Drive Strap Zinc	NP	Nail Plate	SP-SV	Selecta Products Safety Vest
CG	Caulking Gun	NSP	Nylon Switch Plate Screw	SP-TM	Selecta Products Tape Measure
CMD	Concrete Masonry Drill	OWRDT	One-Way Removal Drive Tool	SP-UT	Selecta Products Underground Tape
CS	Cable Staple	PAK	Plastic Anchor Kit	SPDA	Split Drive Anchor
CSF	Concrete Screw Flat Head	PCDS	Pressure Cast Drive Strap	SPIB	Spanner Insert Bit
CSH	Concrete Screw Hex Head	PCSNI	Plastic Cable Strap - Nail In	SPK	Switch Plate Screw Kit
CSHK	Concrete Screw Hex Key	PDW	Pan Head Drywall Screw	SRH	Stainless Round Head Machine Screws
CSIT	Concrete Screw Installation Tool	PSC	Pan Head Self Drill Drywall Screw	SSAE	Stainless Steel Flat Washer
CSMHD	Concrete Screw Hex Driver	PSI	Perforated Strap Iron	SSBW	Stainless Steel Belleville Washer
CSPHH	Concrete Screw Phillips Driver	PT	Pigtail-Insulated	STOP	Stopper Drive Tool
CTT	Cable Tie Tool	PTA	Plastic Toggle Anchor	STS	Stainless Steel Pan Head Tapping Screw
DAB	Dial-A-Bit Kit	PTAK	Plastic Toggle Anchor Kit	TAP	Carbon Steel Taps
DAD	Dial-A-Drill Kit	PTB	Pigtail-Bare Wire	TBK	Twenty-Bit-Kit
DEK	Deck Screw Yellow Chromate	PTS	Pigtail-Stranded Wire	TD	Twist Drill
DES	Double Expansion Shield	QD	Speed Point Drill Screw	TDBS	Tap & Drill Bit Set
DLC	Double Loop Jack Chain	R	Round Head Toggle Bolt	TDK	Twist Drill Kit
DP	Drive Pin	RB	Reciprocating Saw Blades	TDN	Twist Drills Numbered Sizes
DS	Drill Screw	RC	Rod Couplings	TIE	Cable Tie
DSC	Drill Screw Chuck	RH	Round Head Machine Screw	TK	Self Drill Screws Hex Head
DW	Drywall Screw	RNA	Round Head Nylon Anchor	TKED	Self Drill Extended Drill Screws
DWS	Drywall Saw	RSB	Round Head Stove Bolts	TKP	Self Drill Screws Pan Head Phillips
DWG	Drywall Screw Galvanized	RTD	Ratchet Tie Down	TKSD	Self Drill Screws Pan Head Square
EB	Eye Bolt	RW	Reducing Washers	TN	Tites Lock Nut
EC	Eye Coupling	SA	Sleeve Anchors	TNA	Truss Head Nylon Anchor
EZT	E-Z Toggle	SAE	SAE Flat Washers	TPK	Tamperproof Driver Kit
F	Flat Head Toggle Bolt	SBA	Set Bolt Anchors	TR	Threaded Rod
FA	First Aid	SBE	Spade Bit Extension	TS	Pan Head Tapping Screw
FCS	Cable Staple 500 Pak	SBHCS	Silicon Bronze Hex Cap Screws	TSF	Tapping Screw Flat Head Phillips
FFH	Fluorescent Fixture Hook	SBLW	Silicon Bronze Lock Washer	TSFSD	Tapping Screw Flat Head Square Drive
FH	Flat Slotted Machine Screw	SBN	Silicon Bronze Nut	TSIB	Torx Security Insert Bit
FHP	Flat Phillips Machine Screw	SBW	Silicon Bronze Washer	TSS	Tapping Screw Pan Head Stainless
FP	Flat Phillips Wood Screw	SC	Self Drill Dry Wall Screw	TTW	Tap Wrench Handle
FS	Flat Slotted Wood Screw	SCW	Wafer Head Self Drill Drywall Screw	TW	Toggle Wing
FW	Fender Washer	SDA	Self Drilling Anchors	TWS	Thinwall Strap
GC	Grounding Clip	SDSW	Screwdriver Six Way	TWWA	Tie Wire Wedge Anchor
GS	Grounding Screw	SDIA	Steel Drop-In Anchors	UC	U-Beam Clamp
GSF	Ground Screw Thread Chaser	SDIAT	Steel Drop-In Anchor Tools	UKFB	Utility Knife Fixed Blade
HB	Hanger Bolt	SDS	Stamped Conduit Drive Strap	UKRB	Utility Knife Retractable Blade
HCS	Hex Cap Screws, Full Thread	SDSHB	SDS Hammer Bits	USS	USS Flat Washers
HDA	Hammer Drive Nail-In Anchor	SE	Screw Eye	WA	Plastic Wall Anchor
HDWA	Hammer Drive Wedge Anchor	SEDBS	Screw Extractor & Drill Bit Set	WAR	Wall Anchor Ribbed
HDT	Hand Drive Tool	SFW	Stainless Fender Washers	WBB	Wood Boring Spade Bit
HMA	Hangermate Anchors	SG	Safety Glasses	WD	Wood Drills
HPAK	Hex Screw Plastic Anchor Kit	SGOG	Safety Goggles	WDOG	Wall-Dog
HS	Hole Saws	SH	Screw Hook	WEG	Wedge Anchors
HSA	Hole Saw Arbors	SHCS	Stainless Steel Hex Cap Screw, Full Thread	WHP	Wafer Head Drywall Screw
				WN	Wing Nut



MANUFACTURERS LINE CARD

PRODUCT DIRECTORY

Anchors

SELECTA®

Auger Bits

SELECTA®

Barricade Tapes

SELECTA®

Batteries

DURACELL®

Energizer®

PROCELL®

UPG®

Battery & Test Clips

Mueller

Bits (Insert)

SELECTA®

Bolts

SELECTA®

Boot Covers

SELECTA®

Chemical, Cleaners & Degreasers

Chemtronics

CRC

Circuit Board Rework & Repair

Circuitworks®

Circuit Breakers

Carling Technologies

CopperLogic / Eaton

Eaton / CopperLogic

E-T-A

Moeller / CopperLogic

Potter & Brumfield

Tyco Electronics / P&B

Contactors

Cutler-Hammer

Eaton

Sprecher + Schuh

Coolers

Pelican®

Crayon Holders

SELECTA®

Crayons (Lumber)

SELECTA®

Desoldering Braid

Chem-Wik®

Soder-Wick®

Detectable Tapes

SELECTA®

Diggers

SELECTA®

Drill Bits

SELECTA®

Duct Seal

SELECTA®

Duct Tapes

SELECTA®

Dusters (Aerosol)

CRC

Chemtronics

Electrical Tapes

SELECTA®

Fasteners

SELECTA®

First Aid Kits

SELECTA®

Flashlights

DAYLITE®

Energizer®

Garrity®

Mag-Lite®

Pelican®

PROCELL®

Glasses

Gateway Safety®

SELECTA®

Smith & Wesson

Gloves

SELECTA®

Goggles

Gateway Safety®

SELECTA®

Hammers (Sledge & Heavy Engineer)

SELECTA®

Hard Hats

Gateway Safety®

SELECTA®

Helmets

Gateway Safety®

SELECTA®

Indicator Lights/ Pilot Lights

Arcoelectric / Elektron

Elektron Components

SELECTA®

Solico

Insulators

Mueller

Knockout Seals (Snap-In & Screw/Bar Type)

SELECTA®

Liquid Level Controls

ABB / SSAC

Go Switch / Topworx

SSAC

Topworx

Lumber Crayon Holders

SELECTA®

Lumber Crayons

SELECTA®

Markers

Sharpie®

SELECTA®

Marking Pens

Sharpie®

SELECTA®

Measuring Tapes

SELECTA®

Motor Protectors

ABB / SSAC

CopperLogic / Eaton

Eaton / CopperLogic

Go Switch / Topworx

Moeller / CopperLogic

Sprecher + Schuh

SSAC

Topworx

Nuts

SELECTA®

Paint

Rust-Oleum

Pens

(Permanent Marking)

Sharpie®

SELECTA®

Permanent Marking Pens

Sharpie®

SELECTA®

Photoelectrics

PEPPERL+FUCHS

Picks

SELECTA®

Post Hole Diggers

SELECTA®

Pressure Sensors

Honeywell

MICRO SWITCH™

Proximity Controls

Go Switch / Topworx

PEPPERL+FUCHS

Topworx

MANUFACTURERS LINE CARD

PRODUCT DIRECTORY

Rakes

SELECTA®

Relays

Potter & Brumfield

SELECTA®

Sprecher + Schuh

Tyco Electronics / P&B

Safety Glasses

Gateway Safety®

SELECTA®

Smith & Wesson

Safety Goggles

Gateway Safety®

SELECTA®

Safety Helmets

Gateway Safety®

SELECTA®

Safety Products

Gateway Safety®

SELECTA®

Smith & Wesson

Safety Vests

SELECTA®

Screws

SELECTA®

Sealed Lead Acid Batteries

UPG®

Shoe Covers

SELECTA®

Shovels

SELECTA®

Silicone Self-Fusing Tapes

SELECTA®

Sledges

SELECTA®

Switches

Arcoelectric / Elektron

Arrow Hart / Eaton

Carling Technologies

Cutler-Hammer

Eaton Commercial

Elektron Components

Honeywell

ITW Switches

LINEMASTER®

MICRO SWITCH™

NKK

SELECTA®

Switches - Mil. Spec

Honeywell

ITW Switches

MICRO SWITCH™

Switch Seals & Guards

AME Corporation

Arcoelectric / Elektron

APM Hexseal

Elektron Components

Tape Measures

SELECTA®

Tapes

SELECTA®

Terminals (Solderless)

SELECTA®

Test Leads

Mueller

Time Delay Relays

ABB / SSAC

SSAC

Tools

SELECTA®

Underground Tapes

SELECTA®

Vests

SELECTA®

Vinyl Electrical Tapes

SELECTA®

Washers

SELECTA®

Work Gloves

SELECTA®

ALPHA DIRECTORY

- ABB / SSAC
- ACORN / SELECTA®
- AME Corporation
- APEM
- APM Hexseal
- Arcoelectric / Elektron
- Arrow Hart / Eaton
- Carling Technologies
- Chemtronics
- Chem-Wik®
- Circuitworks®
- CopperLogic / Eaton
- CRC
- Cutler-Hammer (DPs)
- DAYLITE®
- DURACELL®
- Eaton Commercial
- Eaton / CopperLogic
- Elektron Components
- Energizer®
- E-T-A
- Garrity®
- Gateway Safety®
- Go Switch / Topworx
- Honeywell
- ITW Chemtronics
- ITW Switches
- LINEMASTER®
- Mag-Lite®
- MICRO SWITCH™
- Moeller / CopperLogic
- Mueller (Clips)
- Mueller (Test Leads)
- NKK
- Pelican®
- PEPPERL+FUCHS
- Potter & Brumfield
- PROCELL®
- Rust-Oleum
- SELECTA®
- Sharpie®
- Smith & Wesson (Glasses)
- Soder-Wick®
- Solico
- Sprecher + Schuh
- SSAC
- Topworx
- Tyco Electronics / P&B
- UPG®

Legend

- One
- Two
- Three
- Four



MILLER INDUSTRIAL, INC.

Value Added Distribution

4760 Hammermill Road

Suite 208

Tucker, GA 30084

Phone: 770-270-0076

Fax: 770-270-0767

E-mail: barry@millerindustrial.net

